

ODDER

701-256-1092
701-256-1099

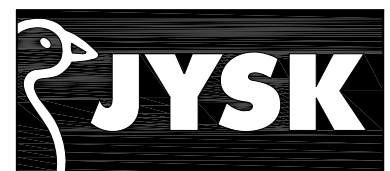

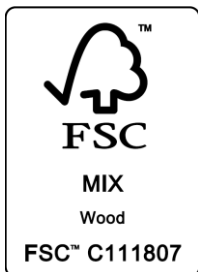

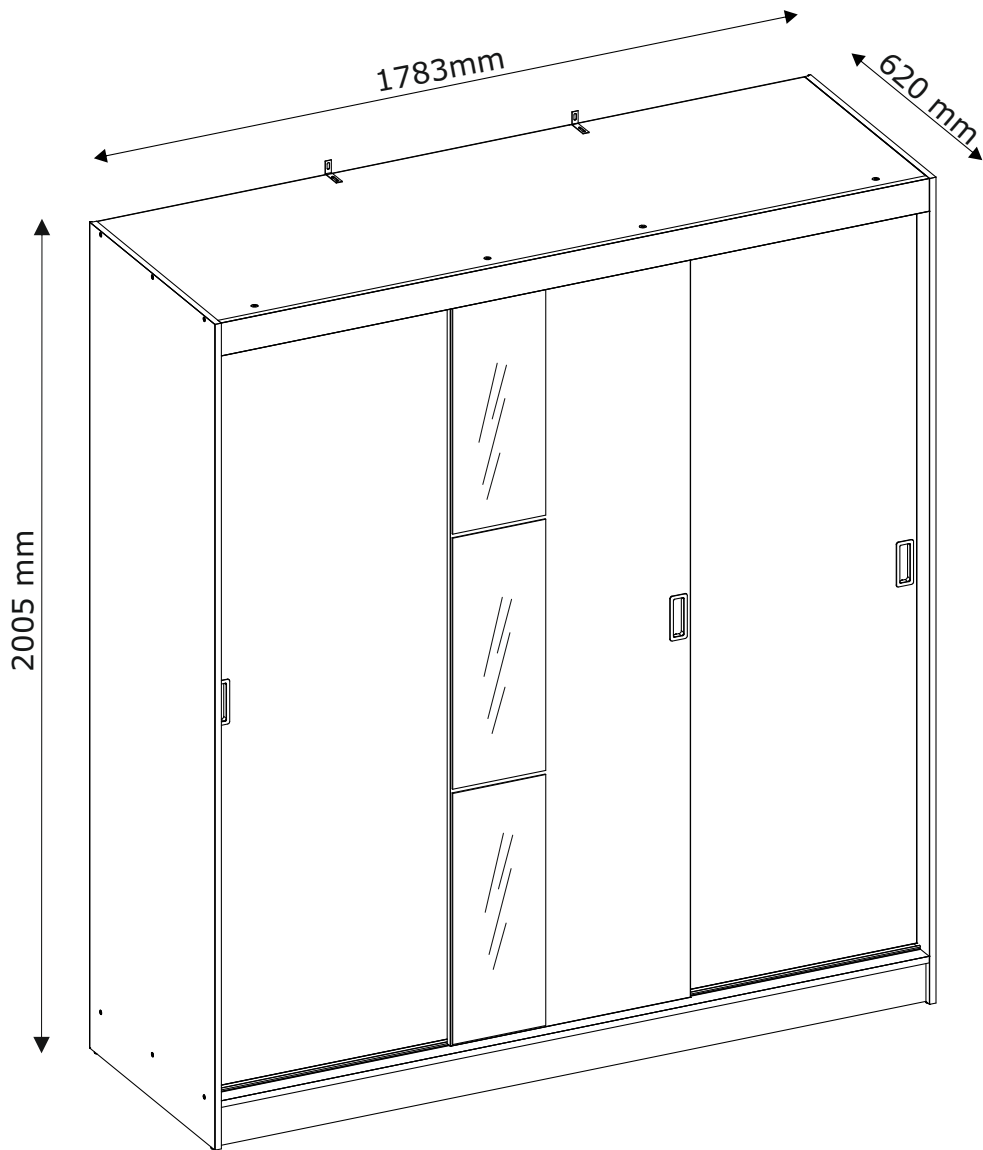
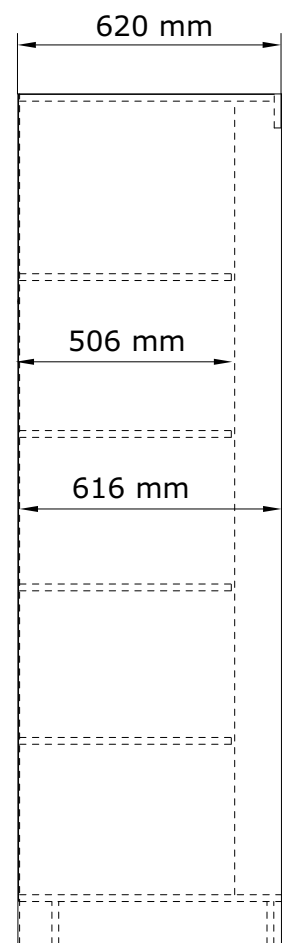
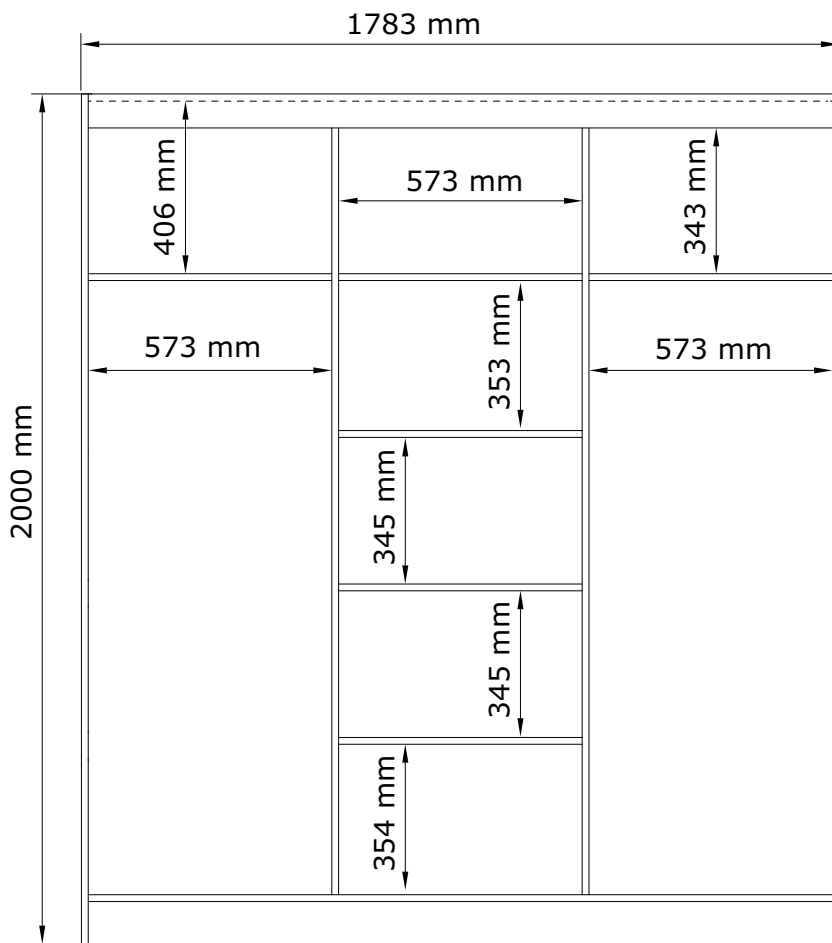
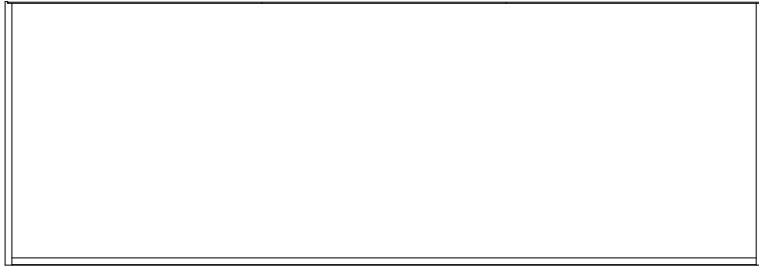

EN: IMPORTANT INFORMATION!

Please read the entire manual carefully before starting to assemble and/or using this product. Follow the manual thoroughly and keep it for further reference.

FR: INFORMATIONS IMPORTANTES

Veillez lire attentivement l'ensemble du manuel avant de commencer à monter et/ou utiliser ce produit. Suivez rigoureusement le manuel et conservez-le pour toute consultation ultérieure.

LV: SVARĪGA INFORMĀCIJA!

Pirms šī izstrādājuma montāžas un/vai lietošanas uzsākšanas pilnībā izlasiet lietošanas pamācību. Stingri ievērojiet pamācības norādījumus un saglabājiet to turpmākai lietošanai.

LT: SVARBI INFORMACIJA!

Prieš pradėdami montuoti gaminį ir (arba) juo naudotis, prašome atidžiai perskaityti visą vadovą. Atidžiai skaitykite vadovą ir turėkite jį su savimi, kad galėtumėte toliau vadovautis jo nuorodomis.

EE: OLULINE TEAVE!

Enne kui alustate toote kokku panemist ja/või kasutamist, lugege see kasutusjuhend hoolikalt läbi. Järgige täpselt juhendis toodud juhiseid ja hoidke juhend alles.

RU: ВАЖНАЯ ИНФОРМАЦИЯ!

Внимательно и полностью прочитайте это руководство, прежде чем приступить к сборке или использованию этого изделия. Следуйте всем инструкциям этого руководства и сохраните его на будущее для справки.

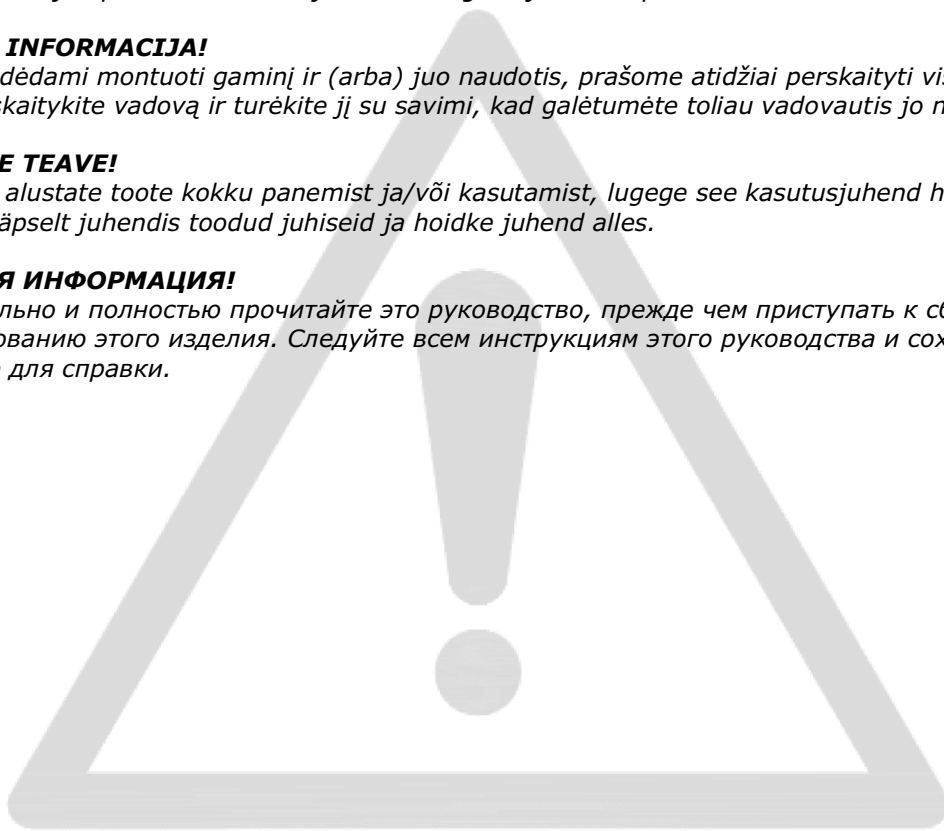

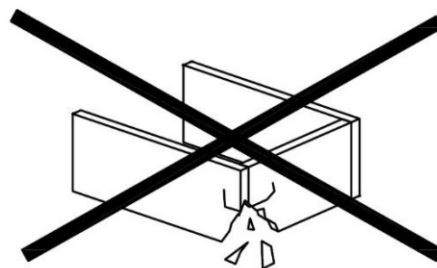
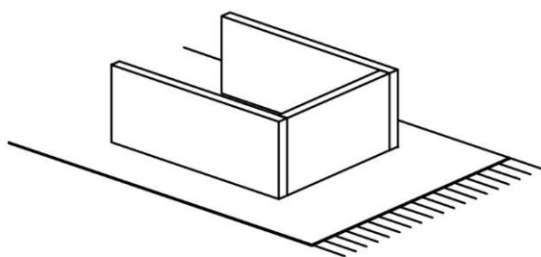

EN: WARNING TO AVOID SCRATCHES!

In order to avoid scratching this furniture should be assembled on a soft layer - could be a rug.

FR: AVERTISSEMENT POUR ÉVITER LES RAYURES

Afin d'éviter les rayures, ce meuble doit être monté sur une surface souple (un tapis, par exemple).

LV: BRĪDINĀJUMS PAR SKRĀPĒJUMIEM!

Lai nesaskrāpētu šo izstrādājumu, veiciet montāžu uz mīkstas pamatnes, piemēram, paklāja.

LT: ĮSPĖJIMAS, KAD IŠVENGTUMĖTE ĮBRĖŽIMŲ!

Šio baldo nesubraižysite, jei jį surinksite ant švelnaus paviršiaus, pavyzdžiui, kilimo.

EE: HOIATUS KRIIMUSTUSTE VÄLTIMISEKS!

Kriimustuste tekkimise vältimiseks mööblile tuleb see kokku panna pehmel pinnal, nt kaltsuvaibal.

RU: ПРЕДУПРЕЖДЕНИЕ ОТНОСИТЕЛЬНО ЦАРАПИН!

Во избежание нанесения царапин, сборку этой мебели необходимо выполнять на мягкой поверхности, например на ковре.

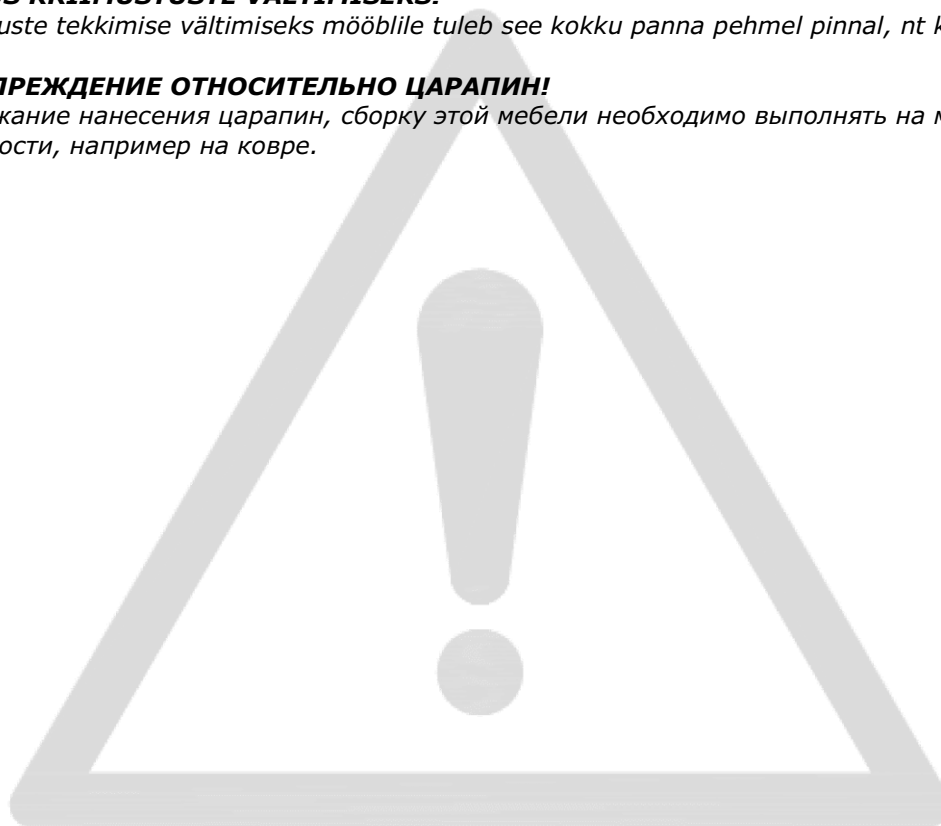

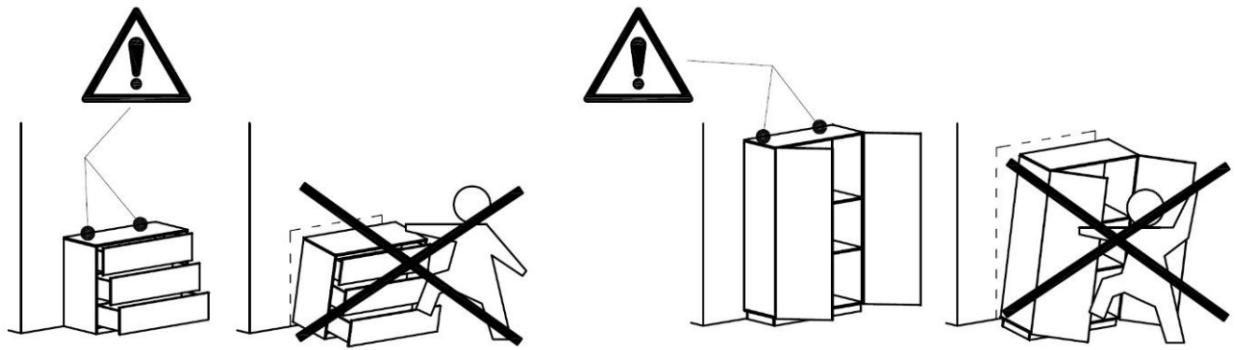

EN: ANTI-TOPPLE WARNING!

This product has to be permanently fixed to the wall with the bracket(s) included, to avoid fatal injury in case it topples over. The pack only contains screws for fastening the anti-topple bracket(s) itself to the product. Please contact your DIY or hardware store for advice on the correct type of screws/raw plugs for your type of wall.

FR: AVERTISSEMENT ANTIBASCULEMENT

Ce produit doit être fixé de manière permanente au mur à l'aide du/des support(s) inclus afin d'éviter des blessures mortelles en cas de basculement. L'emballage contient des vis pour attacher le(s) support(s) antibasculement au produit. Veuillez contacter votre magasin de bricolage ou votre quincaillerie pour obtenir des conseils sur le type de vis/chevilles adapté à votre mur.

LV: BRĪDINĀJUMS PAR APGĀŠANOS!

Šis produkts ir jāpiestiprina pie sienas ar komplektā iekļauto(-ajiem) kronšteinu(-iem), lai novērstu nāvējošu savainojumu risku, tam apgāžoties. Iepakojumā ir skrūves tikai pretapgāšanās kronšteina(-u) piestiprināšanai pie produkta. Informāciju par to, kādas skrūves piemērotas Jūsu sienai, jautājiet saimniecības preču vai būvizstrādājumu veikalā.

LT: ĮSPĖJIMAS DĖL NUVERTIMO!

Šį gaminį būtina tinkamai pritvirtinti prie sienos naudojant pridėtas gembes, kad išvengtumėte mirtino sužalojimo jam nuvirtus. Pakuotėje yra tik varžtai gėbėms prie gaminio pritvirtinti. Užėkite į artimiausią statybinių prekių parduotuvę ir paprašykite savo sienai tinkamiausių varžtų (kaiščių).

EE: ÜMBERKUKKUMISOHT!

Toote ümberkukkumisest tuleneda võiva eluohtliku õnnetuse vältimiseks tuleb see kinnitada komplekti kuuluva(te) kronsteini(de) abil püsivalt seina külge. Komplekti kuuluvad ainult kruvid, mis on mõeldud ümberkukkumist takistava(te) kronsteini(de) kinnitamiseks toote külge. Soovituste saamiseks sobivate kruvide/tüüblite leidmiseks oma seina jaoks, konsulteerige DIY esindaja või rauakaupade kaupluse müüjaga.

RU: ПРЕДУПРЕЖДЕНИЕ ОБ ОПРОКИДЫВАНИИ!

Во избежание опрокидывания это изделие должно быть надежно прикреплено к стене с помощью прилагаемых кронштейнов. В комплект входят винты только для прикрепления кронштейнов к самому изделию. Шурупы и дюбели для крепления к стене конкретного типа можно найти в строительном или хозяйственном магазине.

EN: IMPORTANT!

It is important that any product which is assembled using any kind of screw is re-tightened 2 weeks after assembly, and once every 3 months - in order to assure stability through-out the lifespan of the product.

FR: IMPORTANT

Il est important que tout produit monté à l'aide de vis soit resserré 2 semaines après son montage, puis tous les 3 mois, afin de garantir sa stabilité durant tout son cycle de vie.

LV: SVARĪGI!

Ir svarīgi, lai jebkuram produktam, kas tiek uzstādīts ar jebkādu skrūvju palīdzību, skrūves tiktu atkārtoti pievilktas 2 nedēļas pēc montāžas, pēc tam – reizi 3 mēnešos, tā nodrošinot stabilitāti visā izstrādājuma kalpošanas laikā.

LT: SVARBU!

Bet kokį varžtais tvirtinamą gaminį 2 savaites po surinkimo bei kas 3 mėnesius reikia papildomai suveržti – taip užtikrinamas naudojamo gaminio stabilumas.

EE: TÄHTIS!

Oluline on, et toote kruvisid pingutataks 2 nädalat pärast kokkupanekut ja seejärel iga 3 kuu järel, et tagada stabiilsus kogu toote eluea jooksul.

RU: ВАЖНО!

В любом изделии, собранном с использованием винтов любого типа, необходимо через 2 недели после сборки и в дальнейшем каждые 3 месяца подтягивать винты, чтобы обеспечить прочность изделия в течение срока эксплуатации.





EN: GENERAL INSTRUCTION FOR FURNITURE SURFACES!

*Wipe clean with a damp cloth. Use only water or a gentle detergent.
Wipe dry with a clean cloth.*

FR: INSTRUCTIONS GÉNÉRALES POUR LE MOBILIER

*Nettoyer à l'aide d'un chiffon humide. Utiliser uniquement de l'eau ou un détergent doux.
Essuyer à l'aide d'un chiffon propre.*

LV: VISPĀRĪGI KOPŠANAS NORĀDĪJUMI MĒBEĻU VIRSMĀM!

*Noslaukiet ar mitru drānu. Lietojiet tikai ūdeni vai maigu mazgāšanas līdzekli.
Nosusiniet ar tīru drānu.*

LT: BENDRIEJI NURODYMAI DĖL BALDŲ PAVIRŠIŲ!

*Valykite drėgnu skudurėliu. Naudokite tik vandenį arba švelnų valiklį.
Nusausinkite švarių skudurėliu.*

EE: ÜLDISED JUHISED MÖÖBLIPINDADE JAOKS!





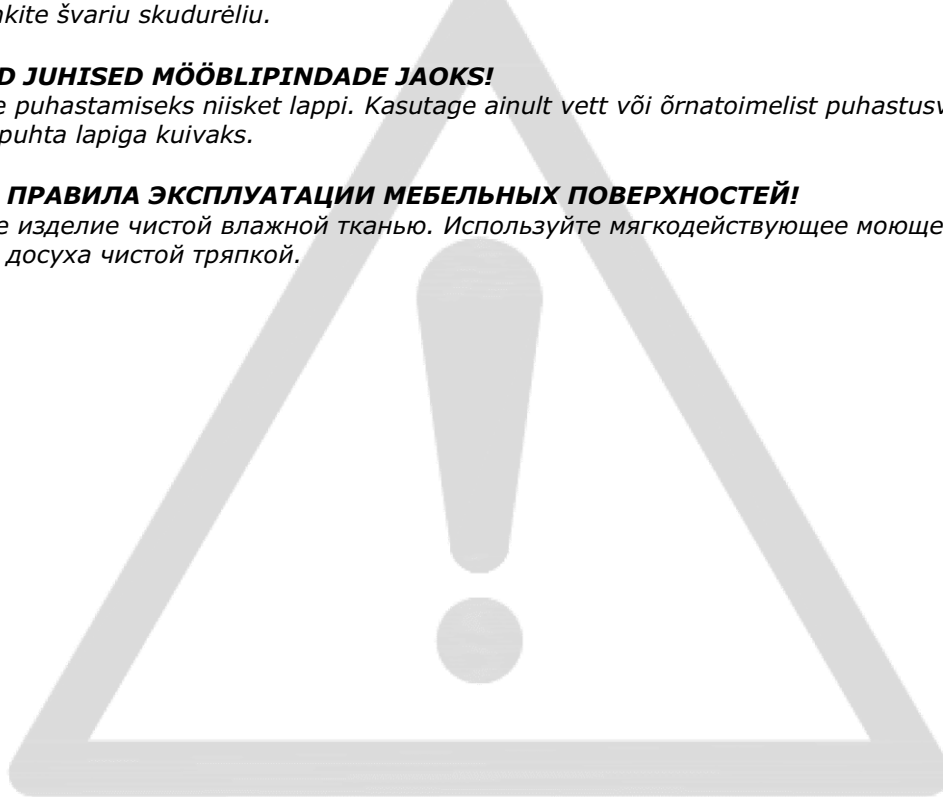

*Kasutage puhastamiseks niisket lappi. Kasutage ainult vett või õrnatoimelist puhastusvahendit.
Pühkige puhta lapiga kuivaks.*

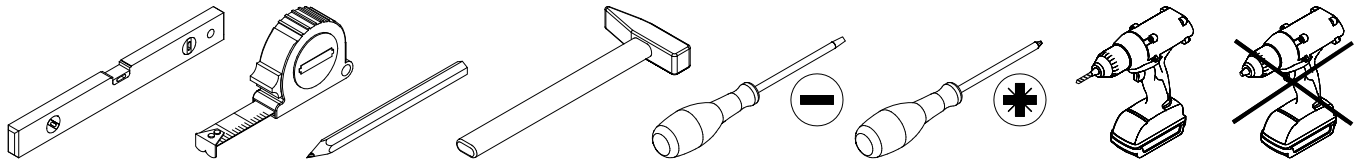
RU: ОБЩИЕ ПРАВИЛА ЭКСПЛУАТАЦИИ МЕБЕЛЬНЫХ ПОВЕРХНОСТЕЙ!

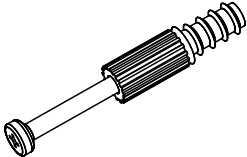
*Очистите изделие чистой влажной тканью. Используйте мягкодействующее моющее средство.
Вытрите досуха чистой тряпкой.*

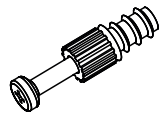
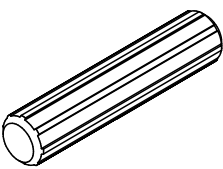
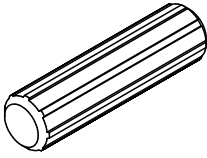
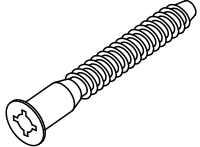
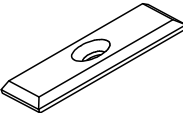

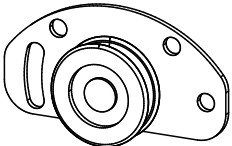
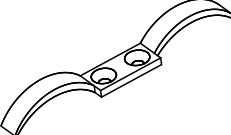
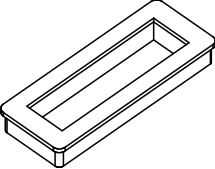
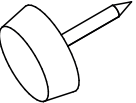
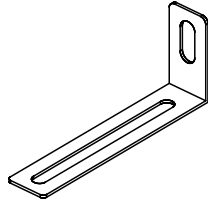
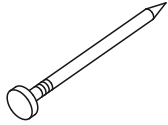
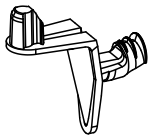

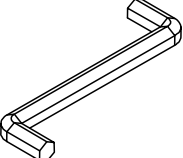
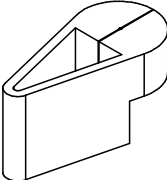
<p>A x 8</p>  <p>Ø7x44 mm</p>	<p>B x 20</p>  <p>Ø15x12 mm</p>	<p>C x 12</p>  <p>Ø7x31 mm</p>	<p>D x 4</p>  <p>Ø8x60 mm</p>
<p>E x 34</p>  <p>Ø8x35 mm</p>	<p>F x 16</p>  <p>Ø6,3x50 mm</p>	<p>G x 24</p>  <p>22x10x2 mm</p>	<p>H x 4</p>  <p>42x17x19 mm</p>
<p>J x 6</p>  <p>71x52x13 mm</p>	<p>K x 6</p>  <p>78x44x14 mm</p>	<p>L x 3</p>  <p>66x8x7 mm</p>	<p>M x 3</p>  <p>108x42x15 mm</p>
<p>N x 8</p>  <p>Ø15 mm</p>	<p>P x 2</p>  <p>75x32x15 mm</p>	<p>Q x 110</p>  <p>Ø1,5x20 mm</p>	<p>R x 12</p>  <p>20x19x11 mm</p>
<p>S x 4</p>  <p>Ø4x16 mm</p>	<p>T x 24</p>  <p>Ø8 mm</p>	<p>U x 1</p>  <p>4 mm</p>	<p>V x 1</p>  <p>19x40 mm</p>

W x 22

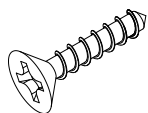

Ø3,5x16 mm

Y x 12

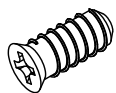

Ø6,3x13 mm

Z x 12



Ø14 mm

AA x 8



Ø3x20 mm

AB x 4

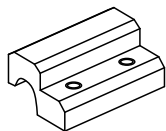

30x17x13 mm

AC x 6



M4x9 mm

AD x 22



Ø3,5x13 mm

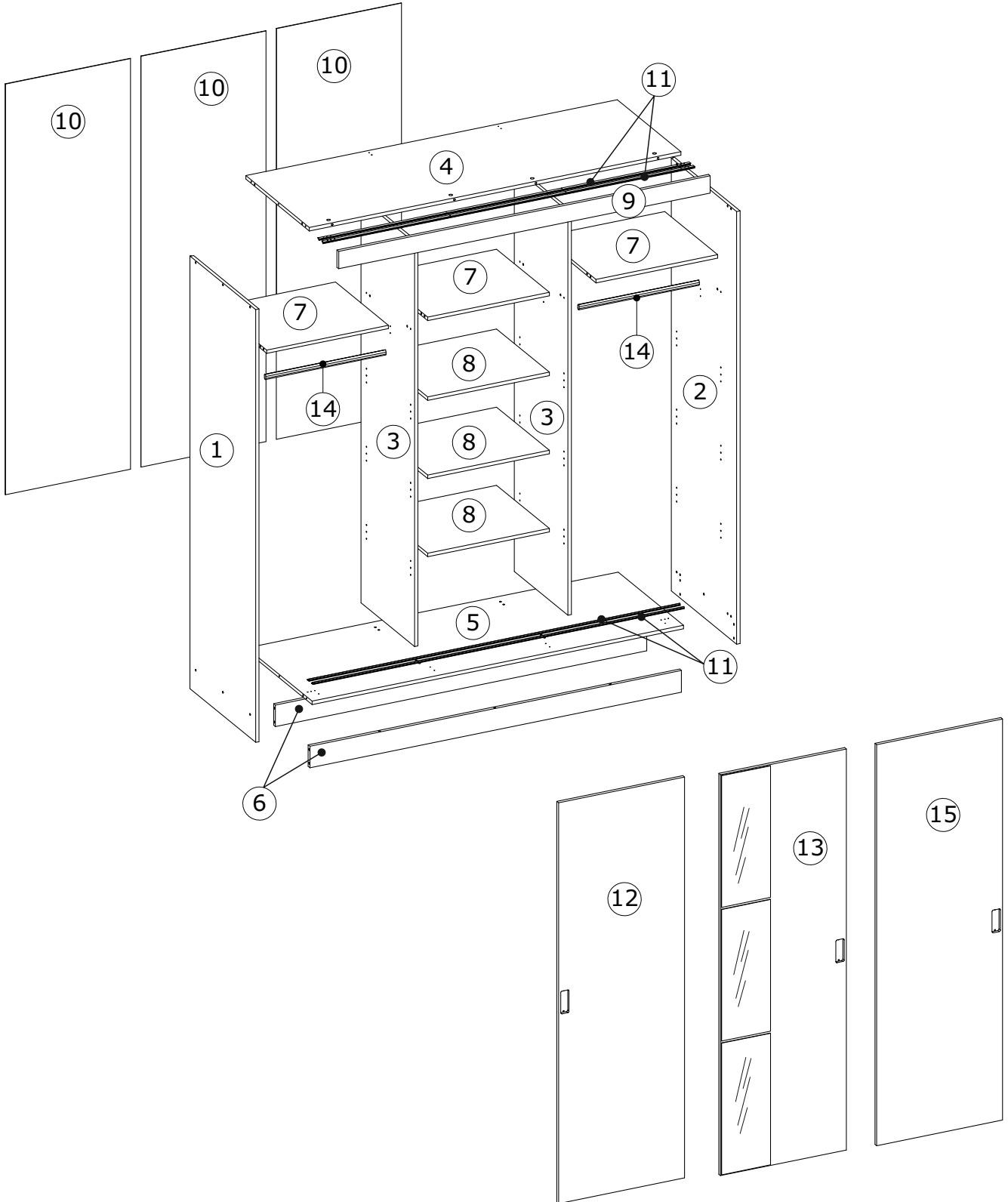
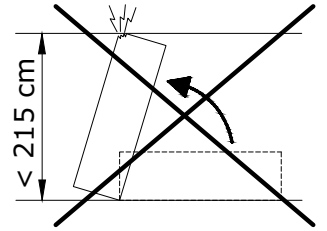
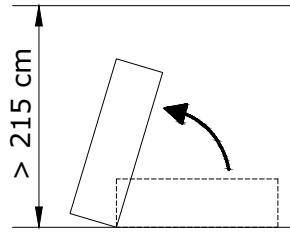
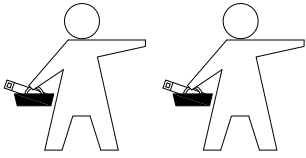

BOX 1/6:

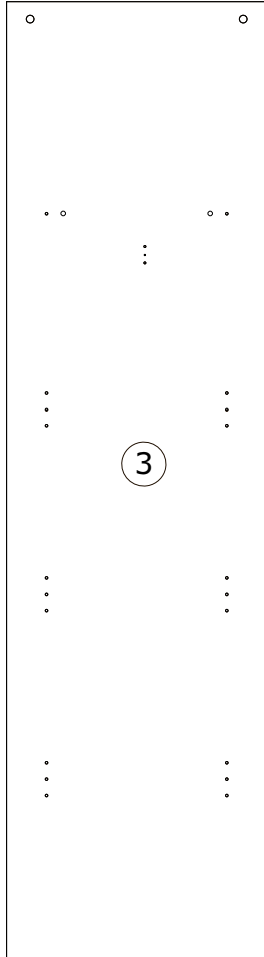

1867x505x16 mm

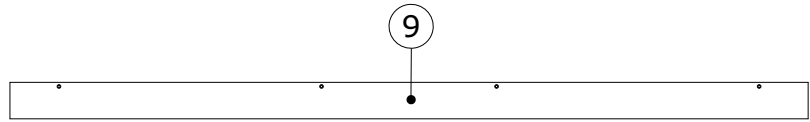

1751x80x16 mm

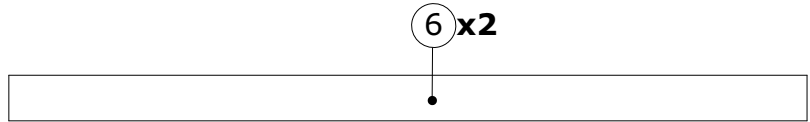

1751x100x16 mm

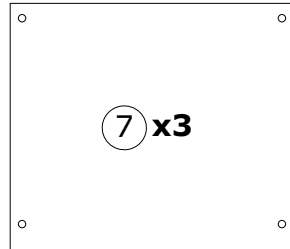

573x498x16 mm

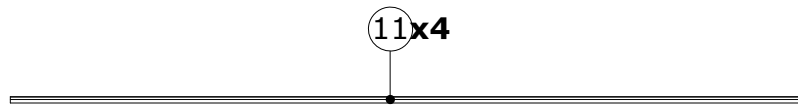

1750 mm

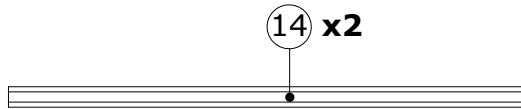

566x20x15 mm

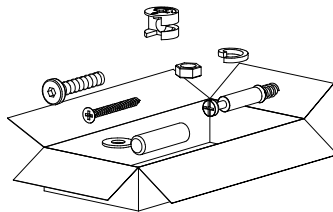

BOX 2/6:

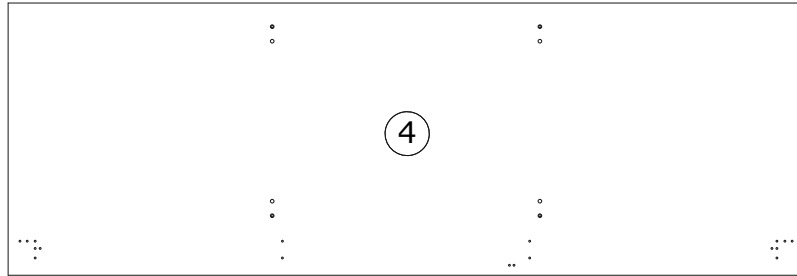

1751x600x16 mm

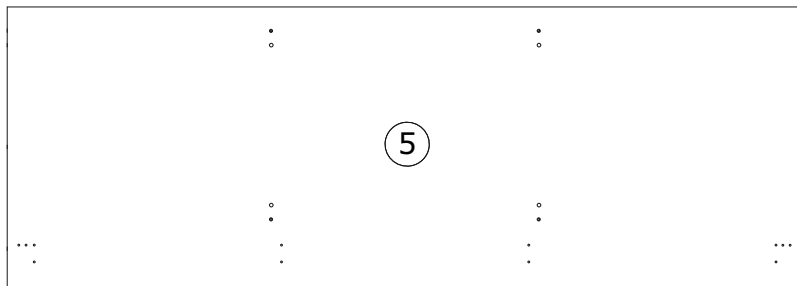

1751x616x16 mm

BOX 3/6:

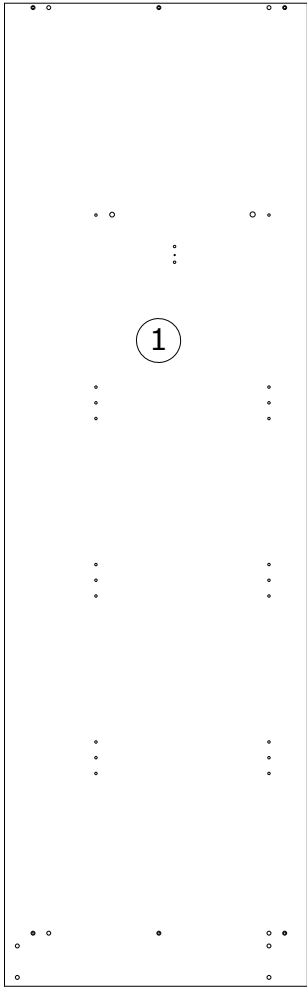

2000x620x16 mm

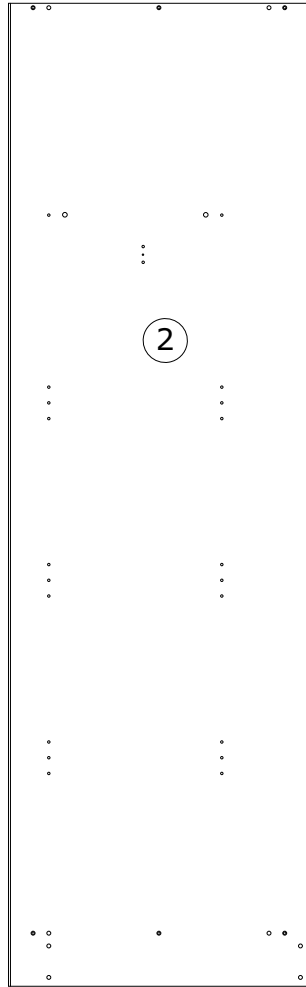

2000x620x16 mm

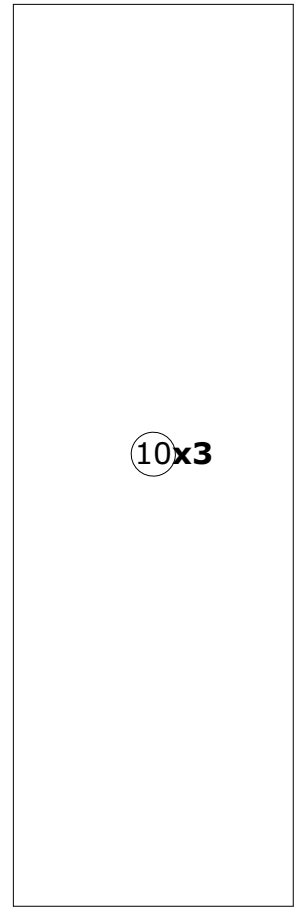

1898x589x2,5 mm

BOX 4/6:

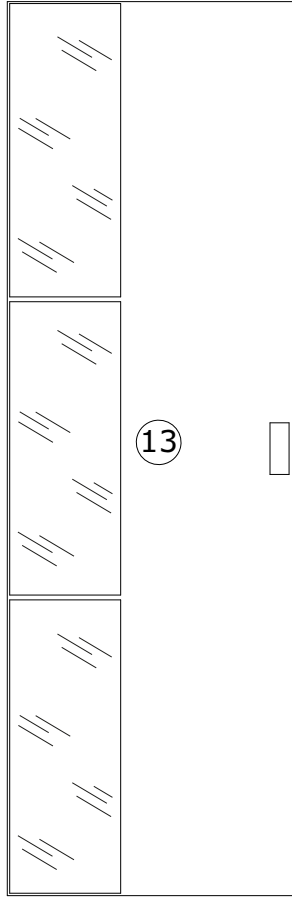

1853x594x19 mm

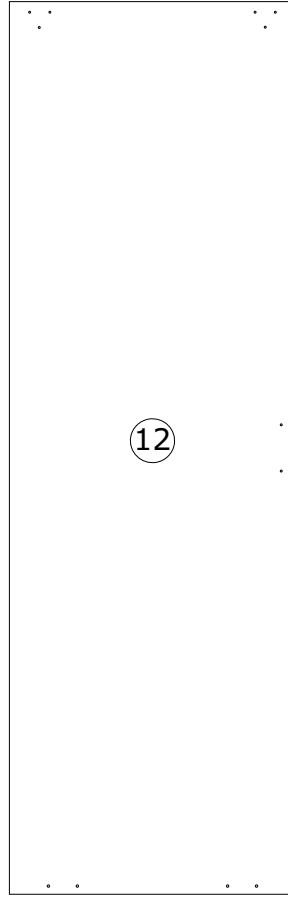

1853x594x16 mm

BOX 5/6:

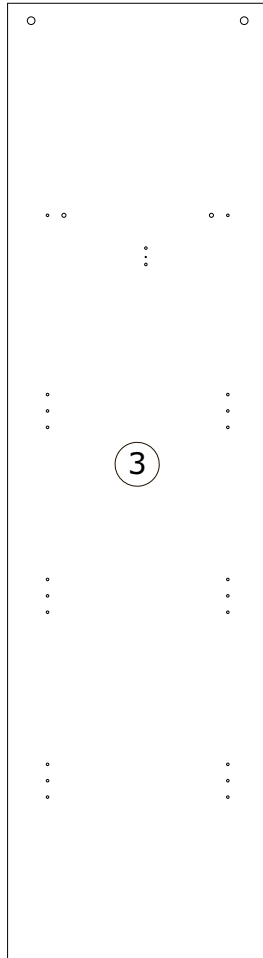

1867x505x16 mm

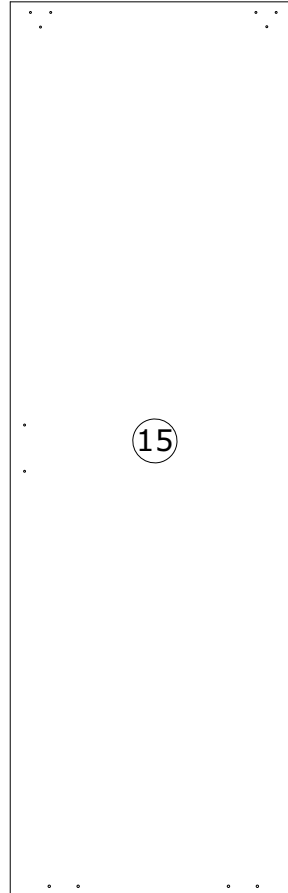

1853x594x16 mm



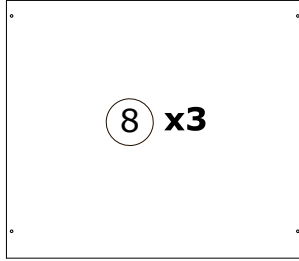

BOX 6/6:





573x498x16 mm

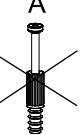

1

E x 4  Ø8x35 mm	C x 2  Ø7x31 mm	 
--	--	---

			
---	---	---	---

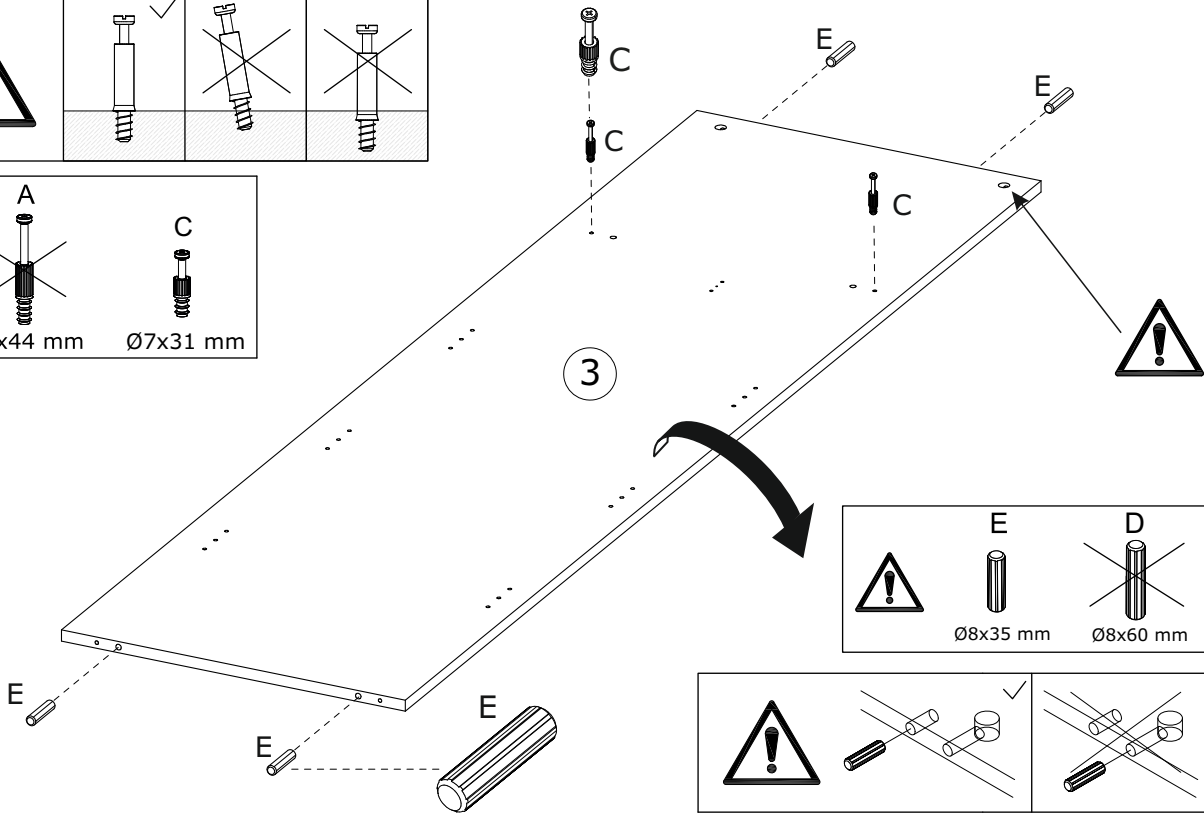
		
	Ø7x44 mm	Ø7x31 mm





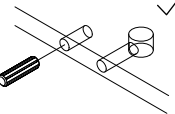
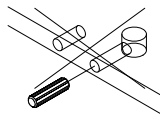





	E  Ø8x35 mm	D  Ø8x60 mm
---	--	---

		
--	--	--

2

C x 2  Ø7x31 mm	H x 1  42x17x19 mm	W x 1  Ø3,5x16 mm	 
--	---	--	---

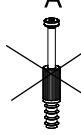

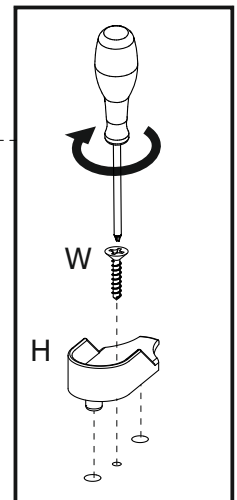
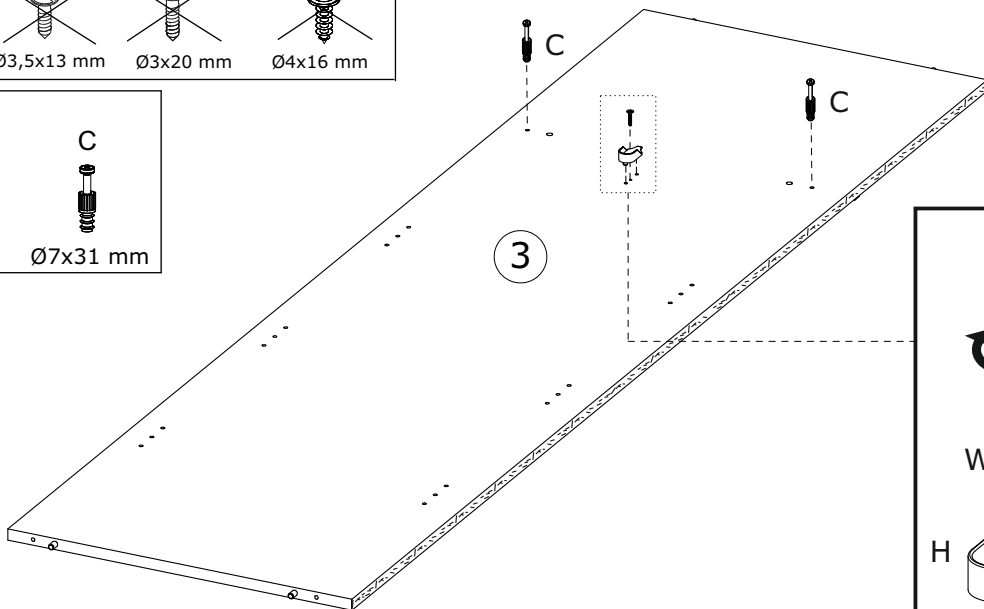

	W  Ø3,5x16 mm	AD  Ø3,5x13 mm	AA  Ø3x20 mm	S  Ø4x16 mm
---	---	--	--	---



		
	Ø7x44 mm	Ø7x31 mm



3

C x 2  Ø7x31 mm	H x 1  42x17x19 mm	W x 1  Ø3,5x16 mm	
--	---	--	---

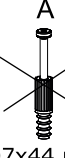

 W  Ø3,5x16 mm	AD  Ø3,5x13 mm	AA  Ø3x20 mm	S  Ø4x16 mm
--	---	---	--

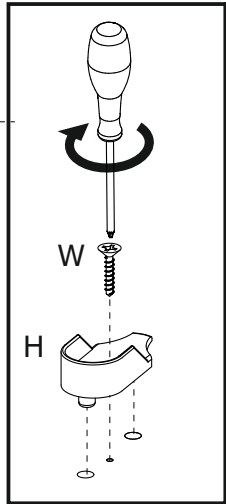
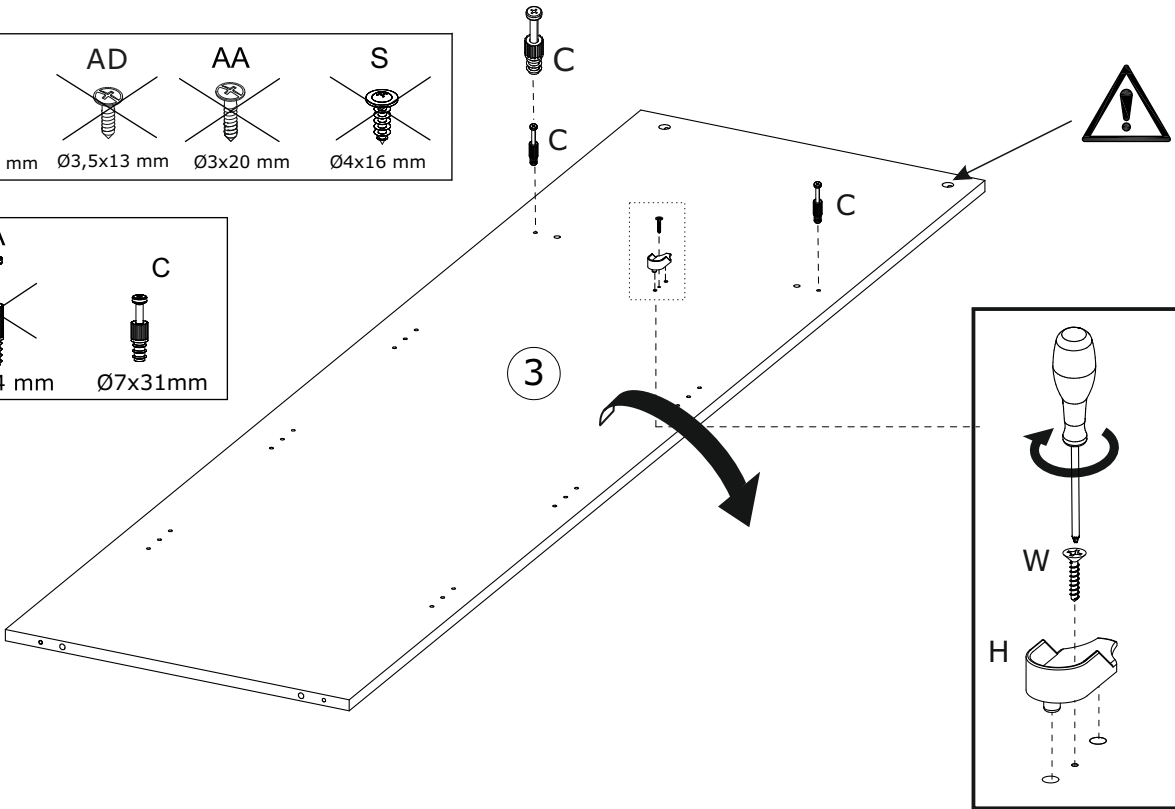

 A  Ø7x44 mm	C  Ø7x31mm
---	---

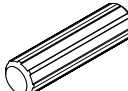
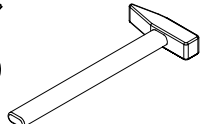

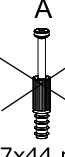
4

C x 2  Ø7x31 mm	E x 4  Ø8x35 mm		
--	--	---	---

 A  Ø7x44 mm	C  Ø7x31mm
---	---

 E  Ø8x35 mm	D  Ø8x60 mm
--	--

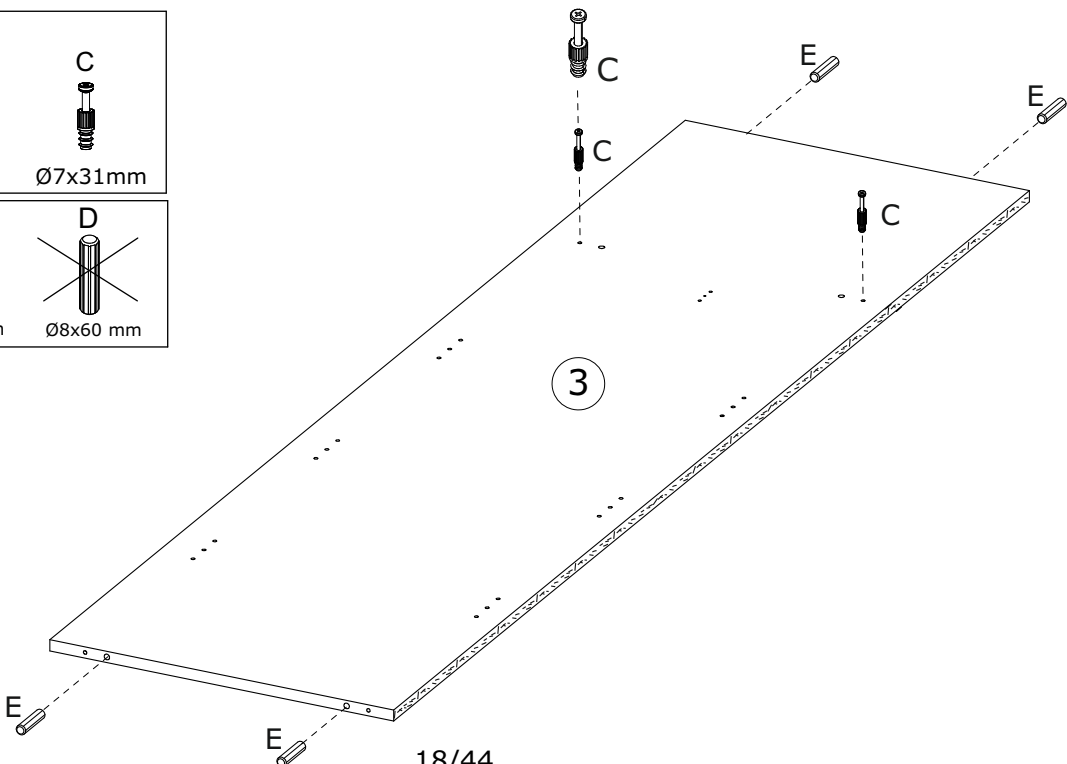

5

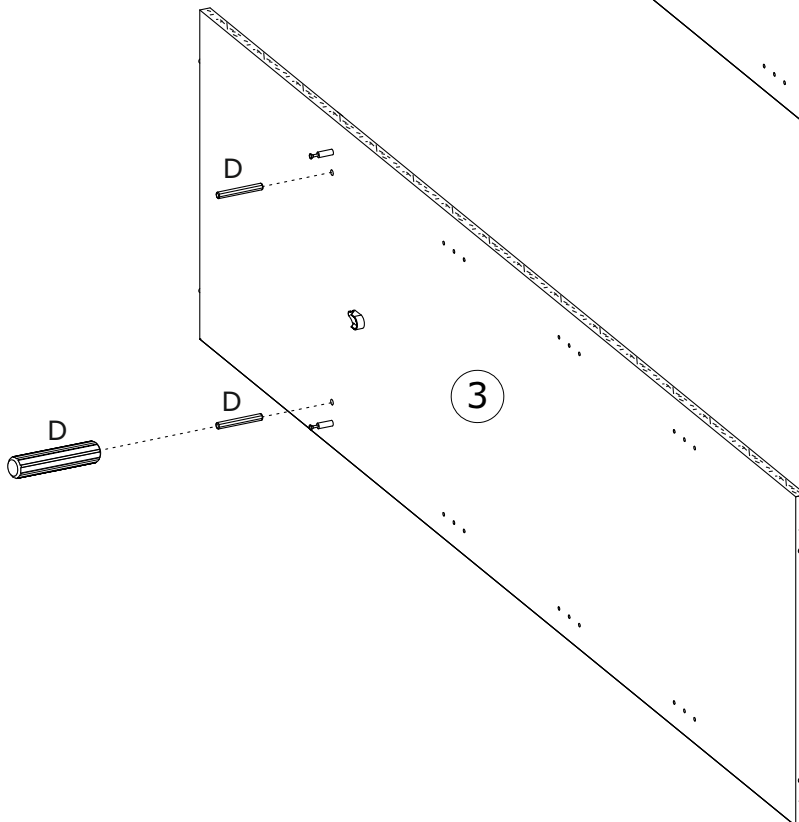
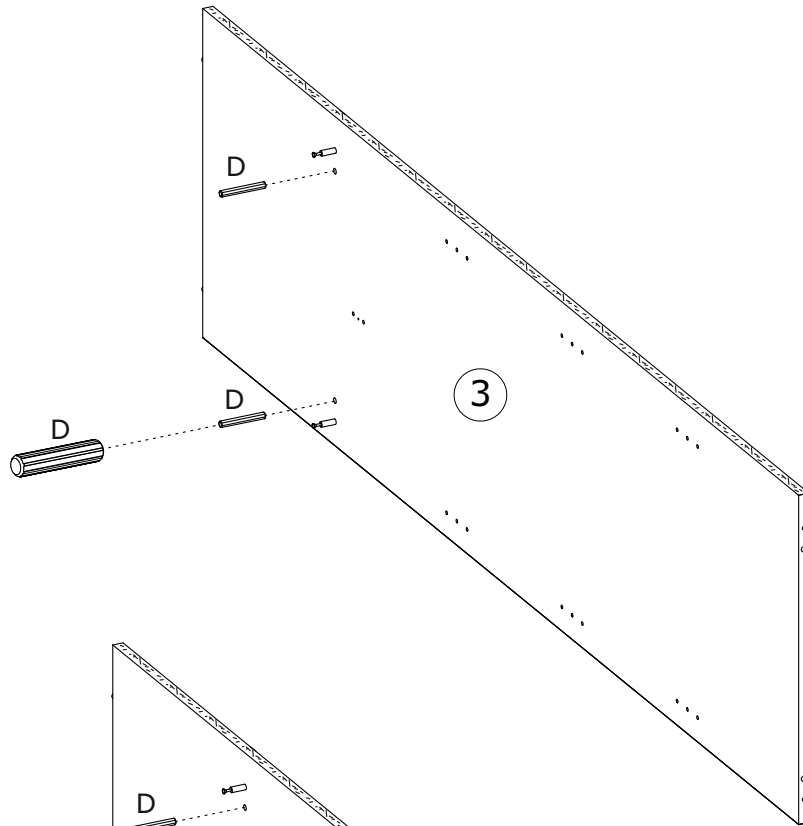
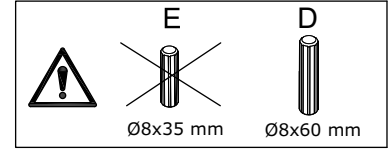
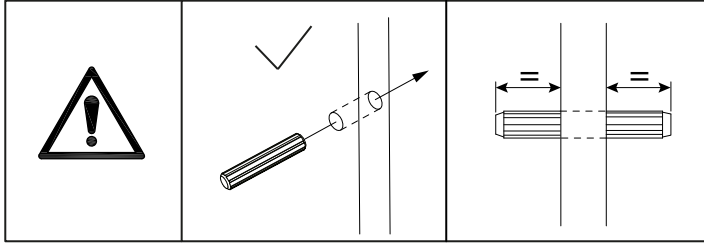
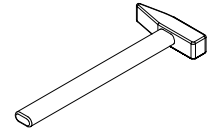
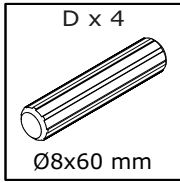

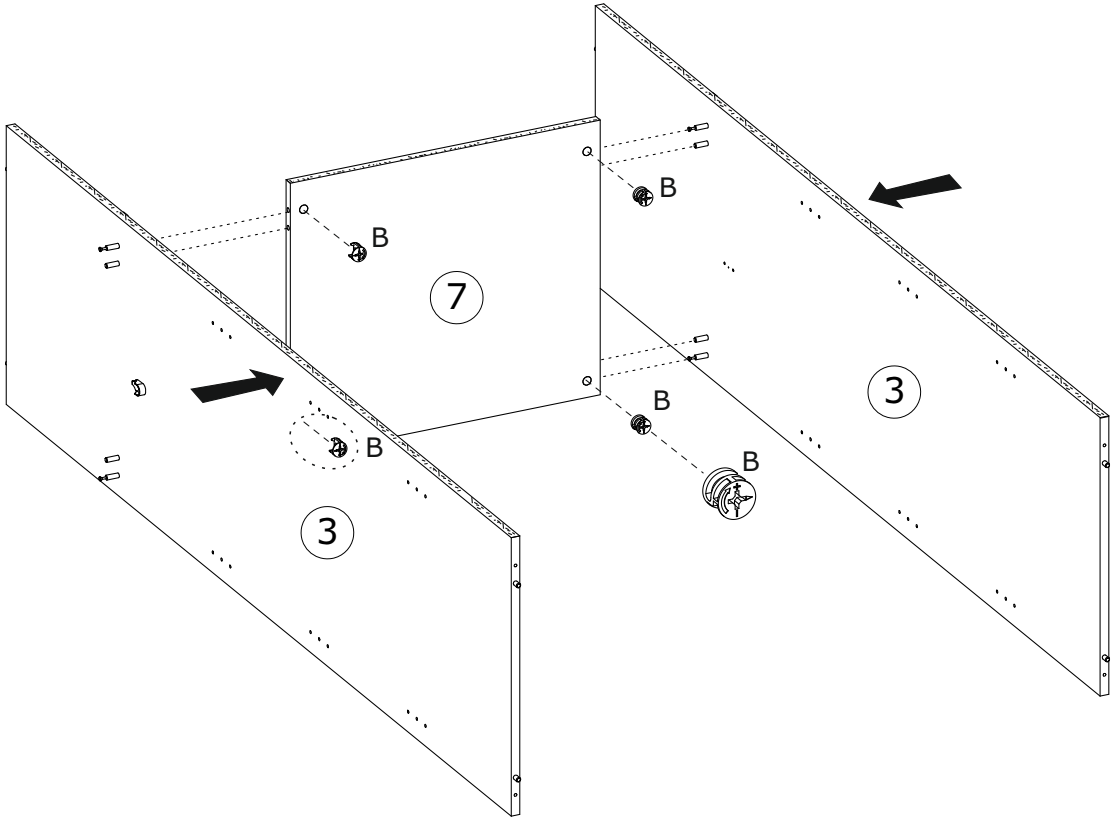
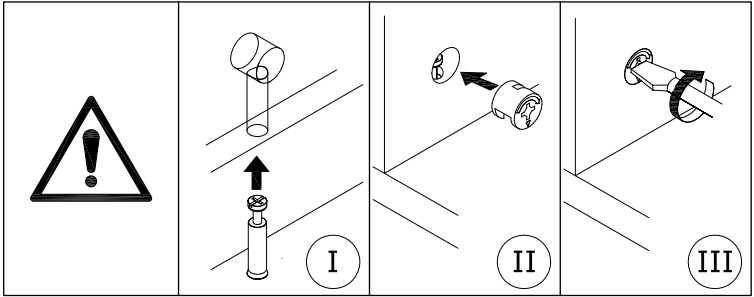
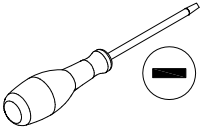

6

B x 4
Ø15x12 mm



7



A x 4  Ø7x44 mm	AD x 8  Ø3,5x13 mm		
--	---	---	---

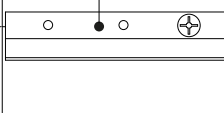

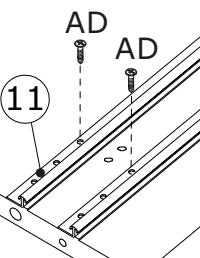

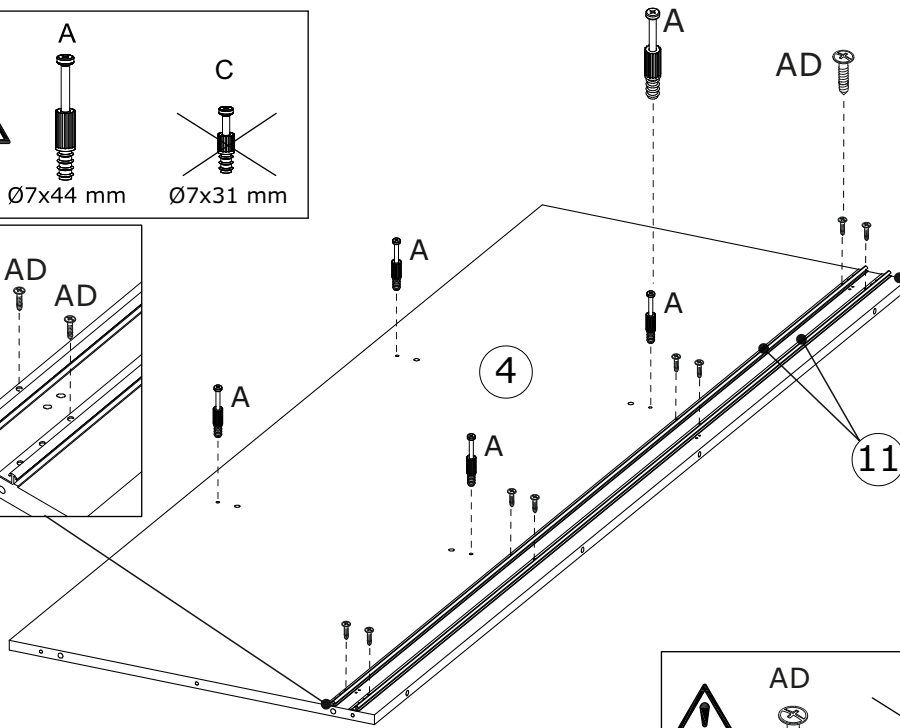
	A  Ø7x44 mm	C  Ø7x31 mm
---	--	--

	11  1mm
---	--

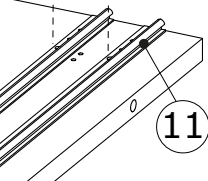
11 









AD 	AD 	11 
---	---	---

	AD  Ø3,5x13 mm	W  Ø3,5x16 mm	AA  Ø3x20 mm	S  Ø4x16 mm
---	---	--	---	--



8

L x 3  66x8x7 mm	AD x 6  Ø3,5x13 mm	
---	---	---

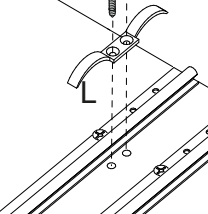
	AD  Ø3,5x13 mm	W  Ø3,5x16 mm	AA  Ø3x20 mm	S  Ø4x16 mm
---	---	--	---	--

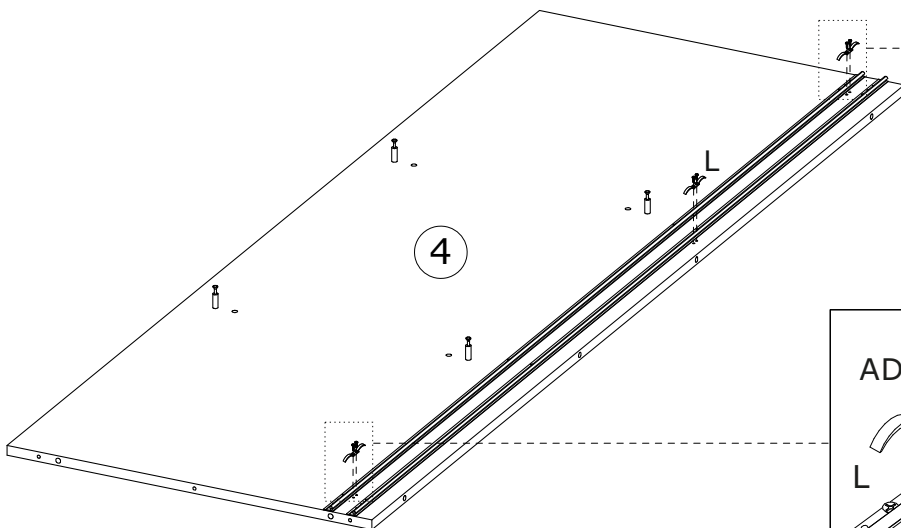
AD 	AD 	L 
---	---	--

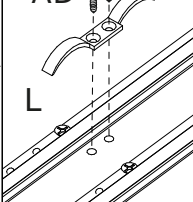

AD 	AD 	L 
---	---	---

9

AA x 4  Ø3x20 mm	AB x 2  30x17x13 mm	
---	--	---

 AA Ø3x20 mm	W Ø3,5x16 mm	AD Ø3,5x13 mm	S Ø4x16 mm
--	----------------------------	-----------------------------	--------------------------

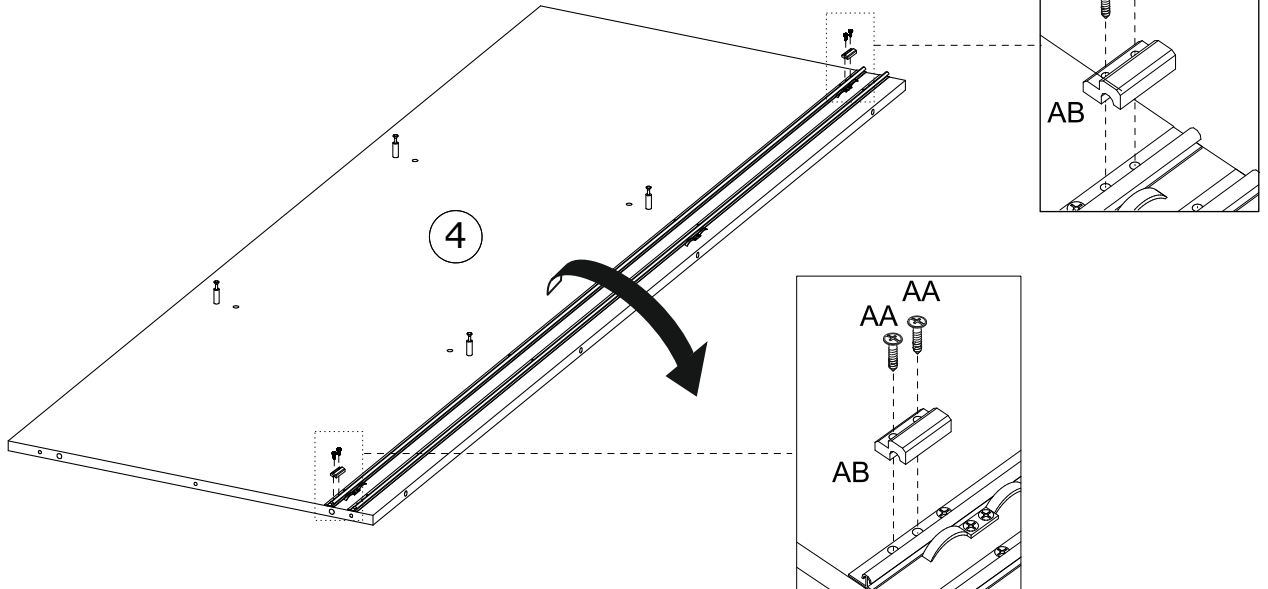

10

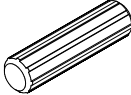
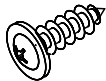
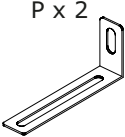
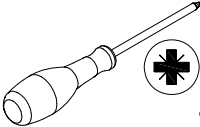
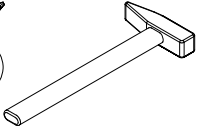
E x 4  Ø8x35 mm	S x 4  Ø4x16 mm	P x 2  75x32x15 mm		
--	--	---	---	---

 S Ø4x16 mm	W Ø3,5x16 mm	AA Ø3x20 mm	AD Ø3,5x13 mm
---	----------------------------	---------------------------	-----------------------------

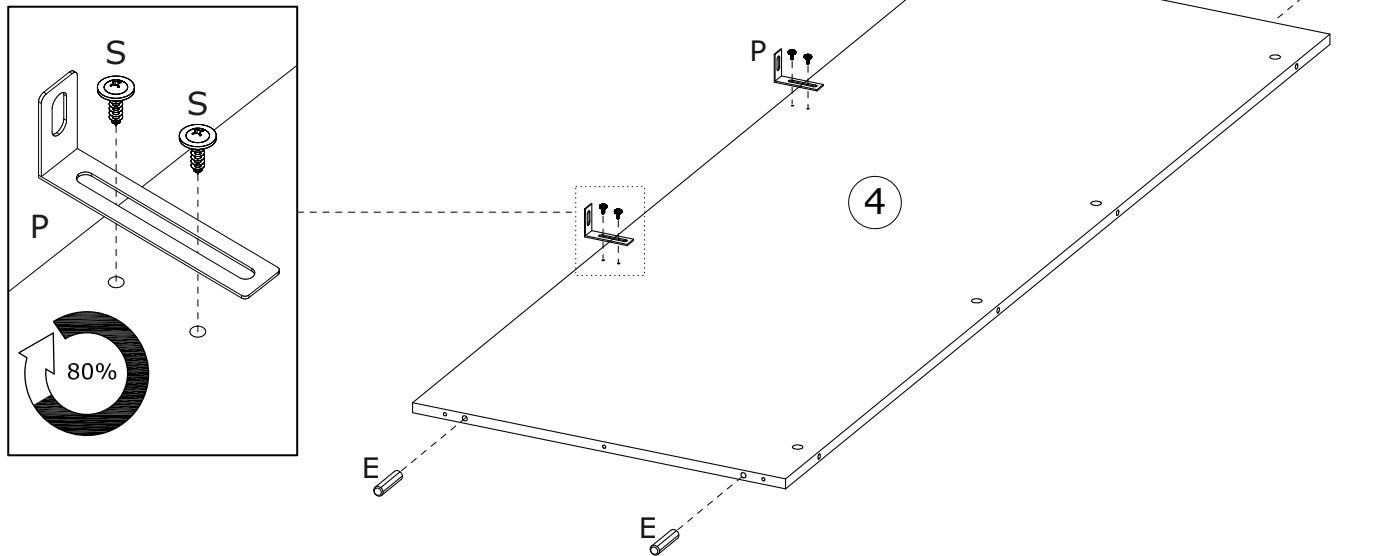

11

AD x 8
Ø3,5x13 mm

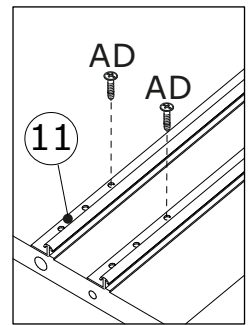
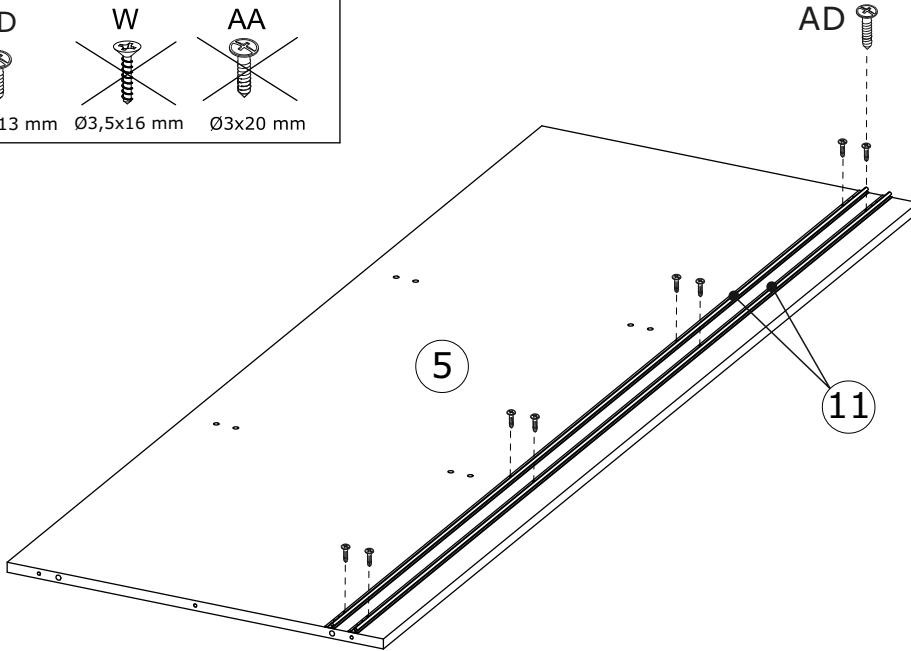
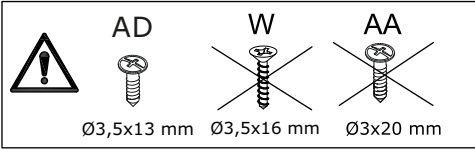
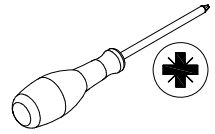

12

E x 4
Ø8x35 mm

AA x 4
Ø3x20 mm

AB x 2
30x17x13 mm

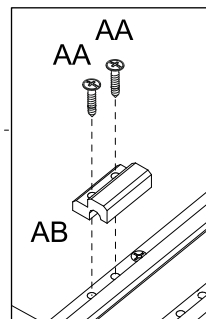
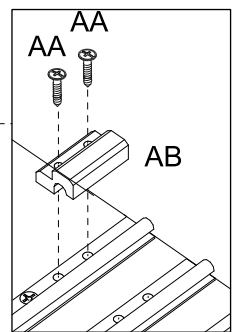
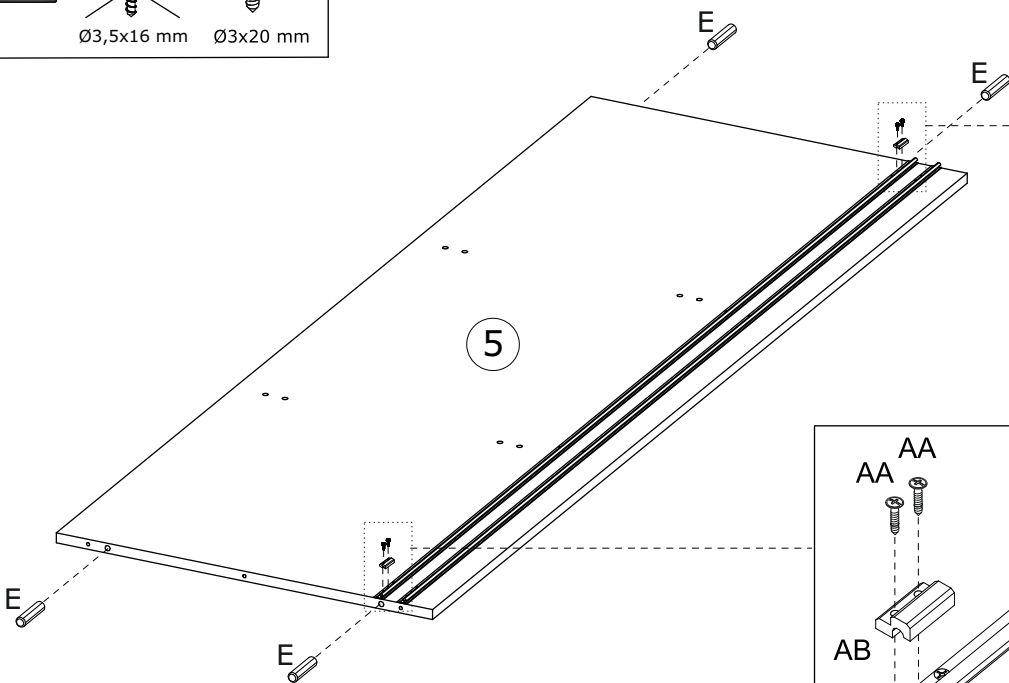
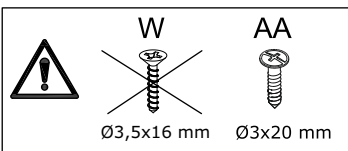
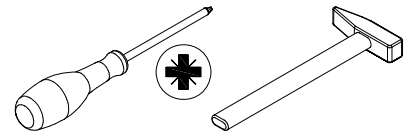

13

<p>B x 4</p>  <p>Ø15x12 mm</p>	<p>F x 4</p>  <p>Ø6,3x50 mm</p>	<p>U x 1</p>  <p>4 mm</p>	
---	--	--	---

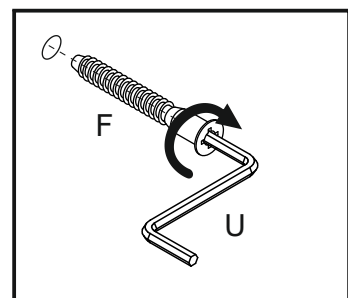
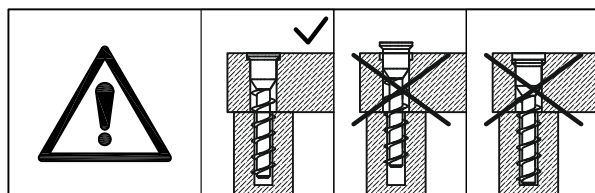
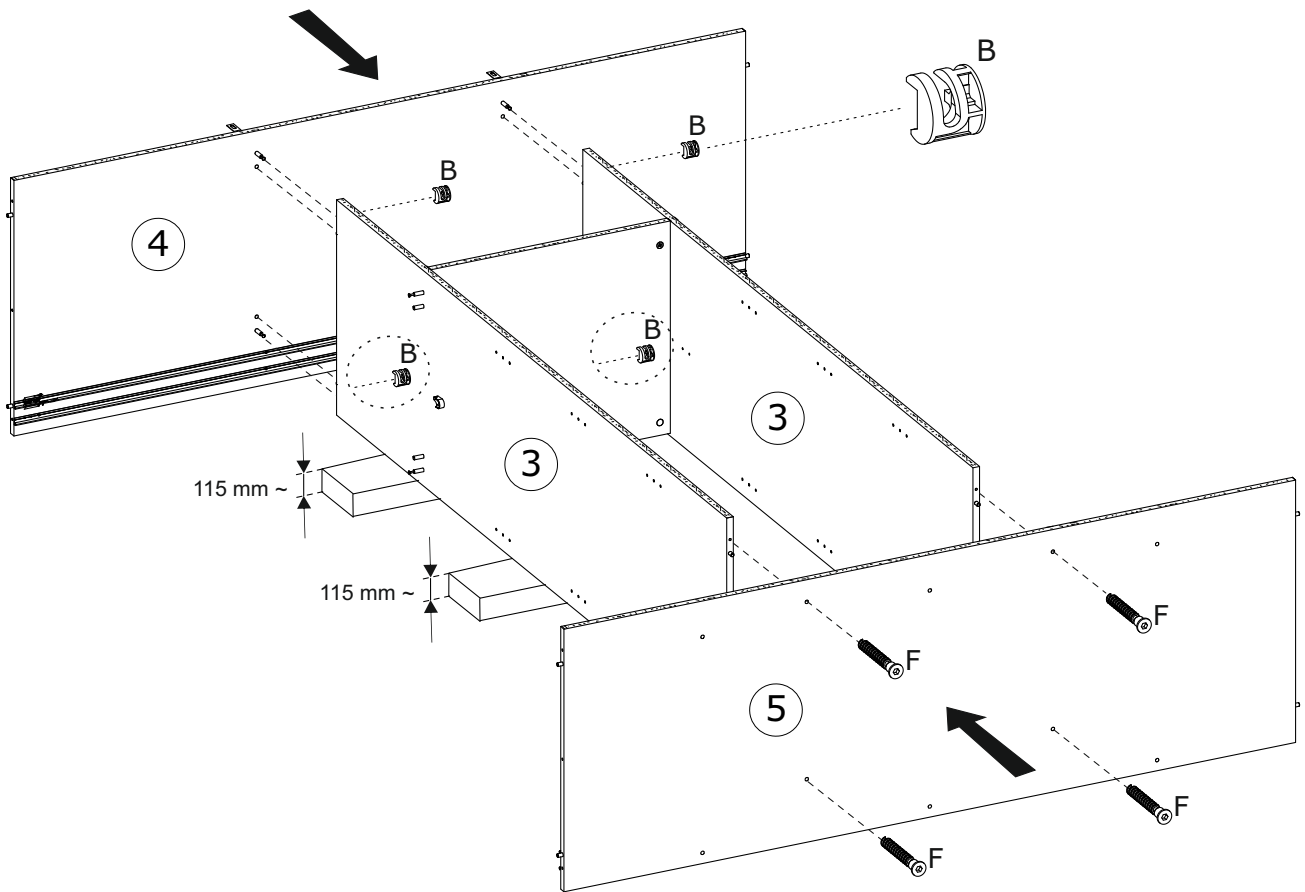
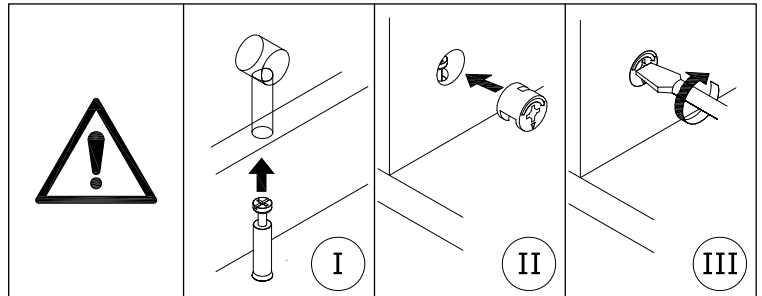

14

E x 4
Ø8x35 mm

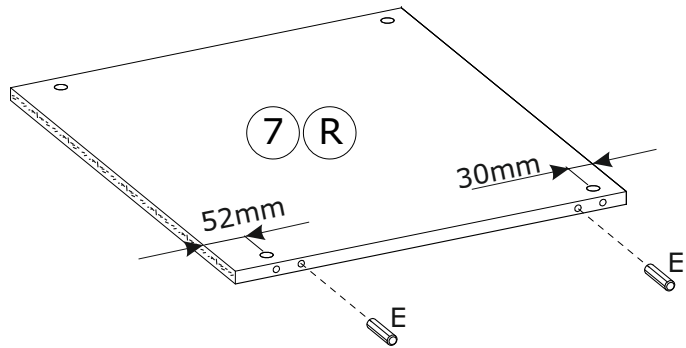
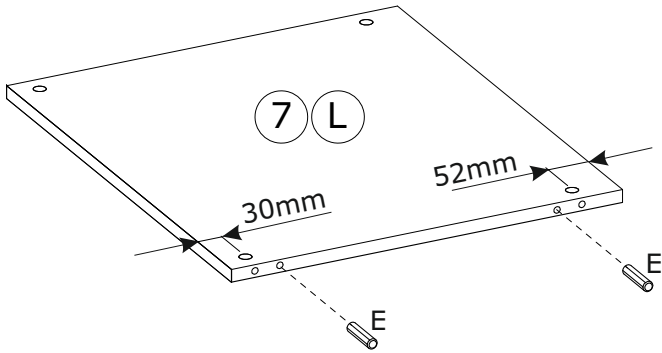
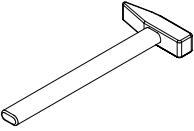

15





B x 4

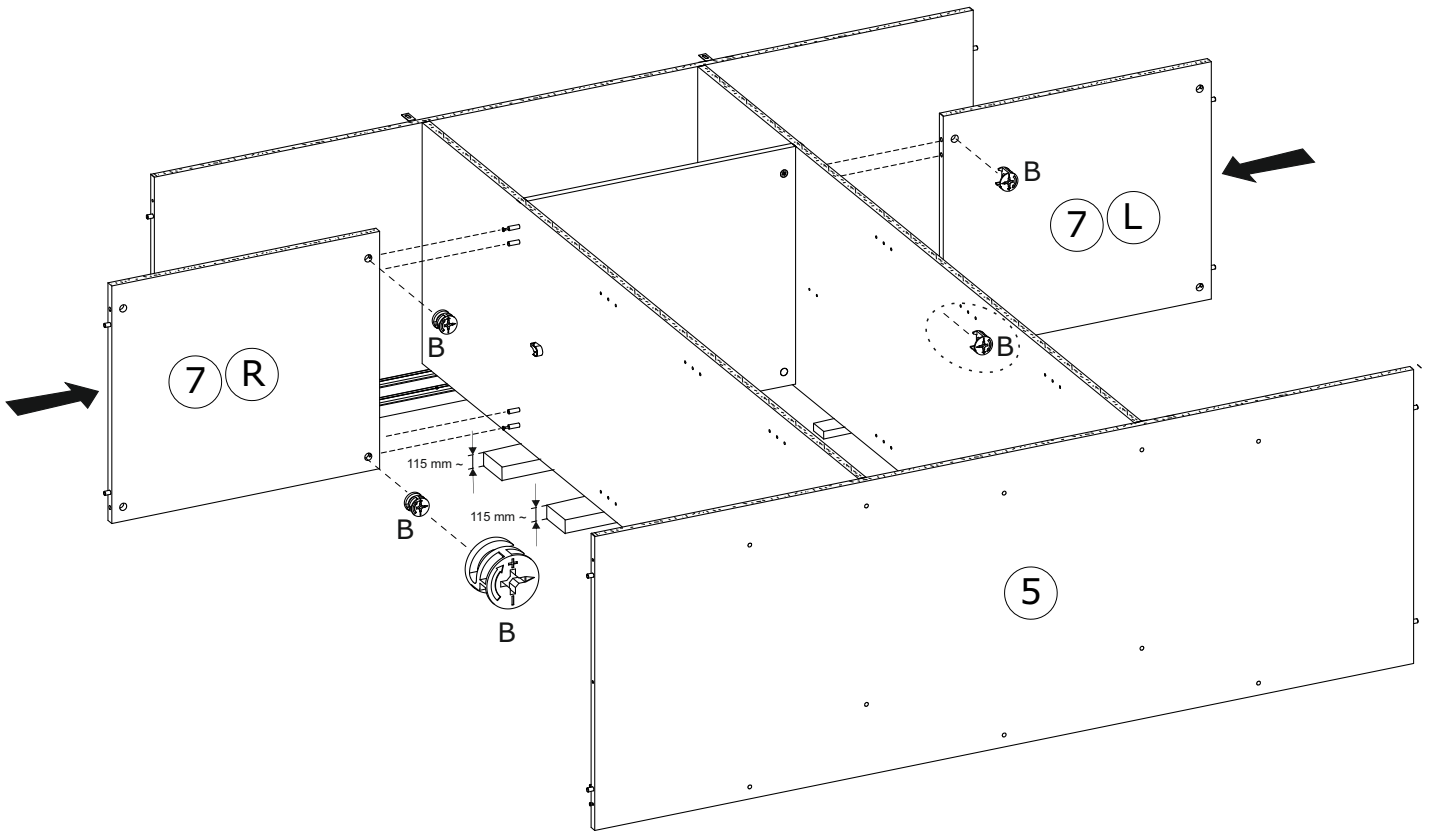

Ø15x12 mm

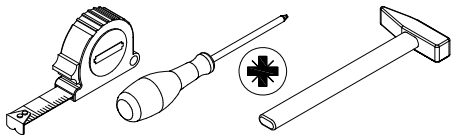

16

N x 2  Ø15 mm	C x 2  Ø7x31 mm	H x 1  42x17x19 mm	W x 1  Ø3,5x16 mm	
--	--	---	--	--

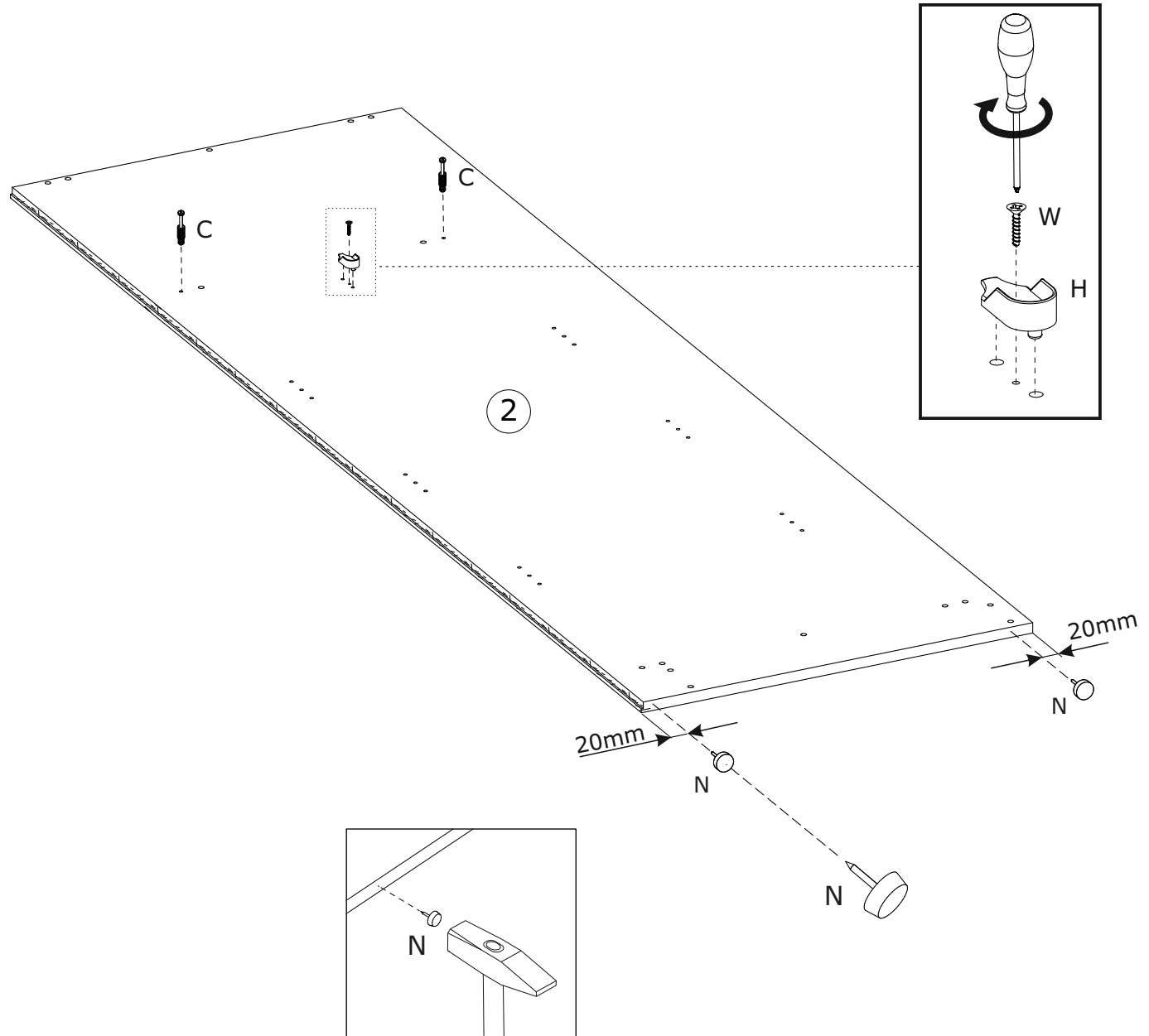
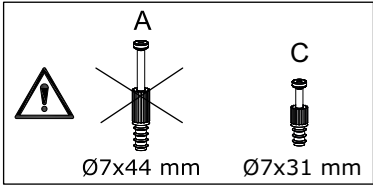

18

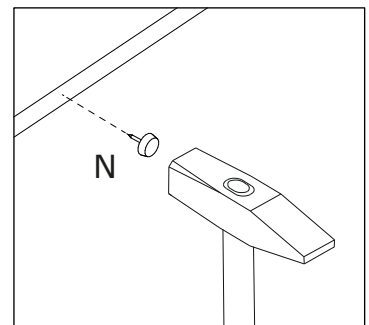
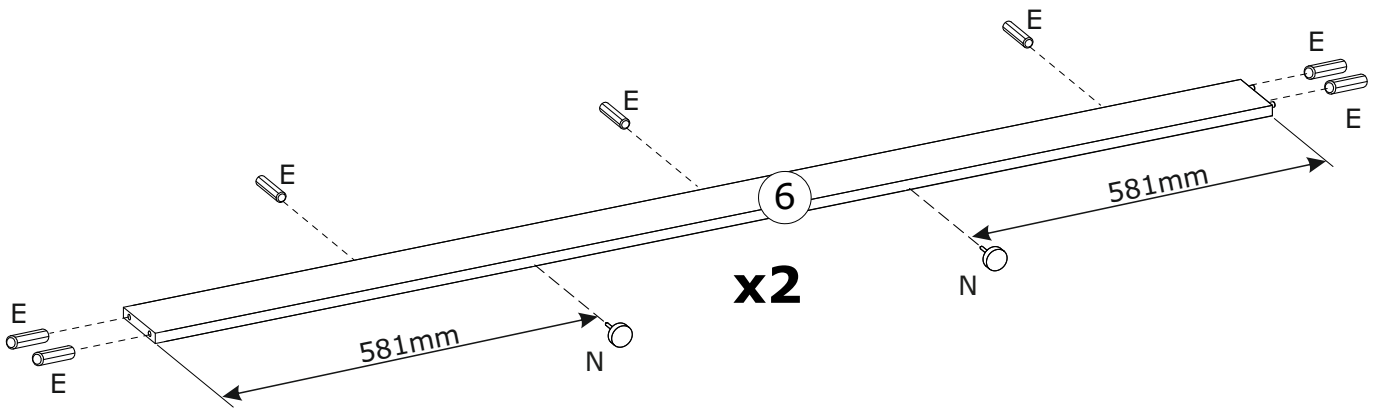

19

<p>B x 4</p>  <p>Ø15x12 mm</p>	<p>F x 12</p>  <p>Ø6,3x50 mm</p>	<p>U x 1</p>  <p>4 mm</p>	
---	---	--	---

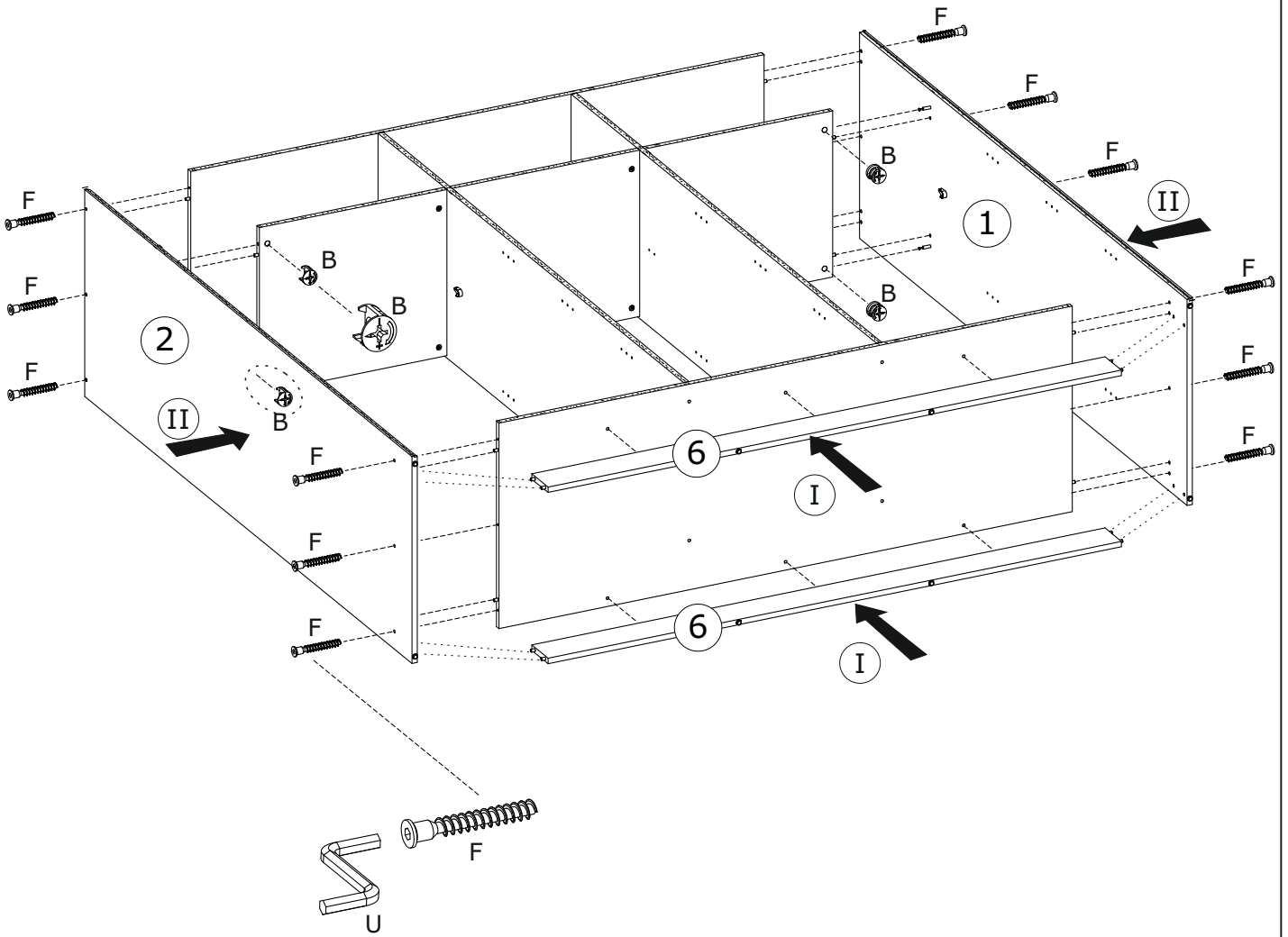

20

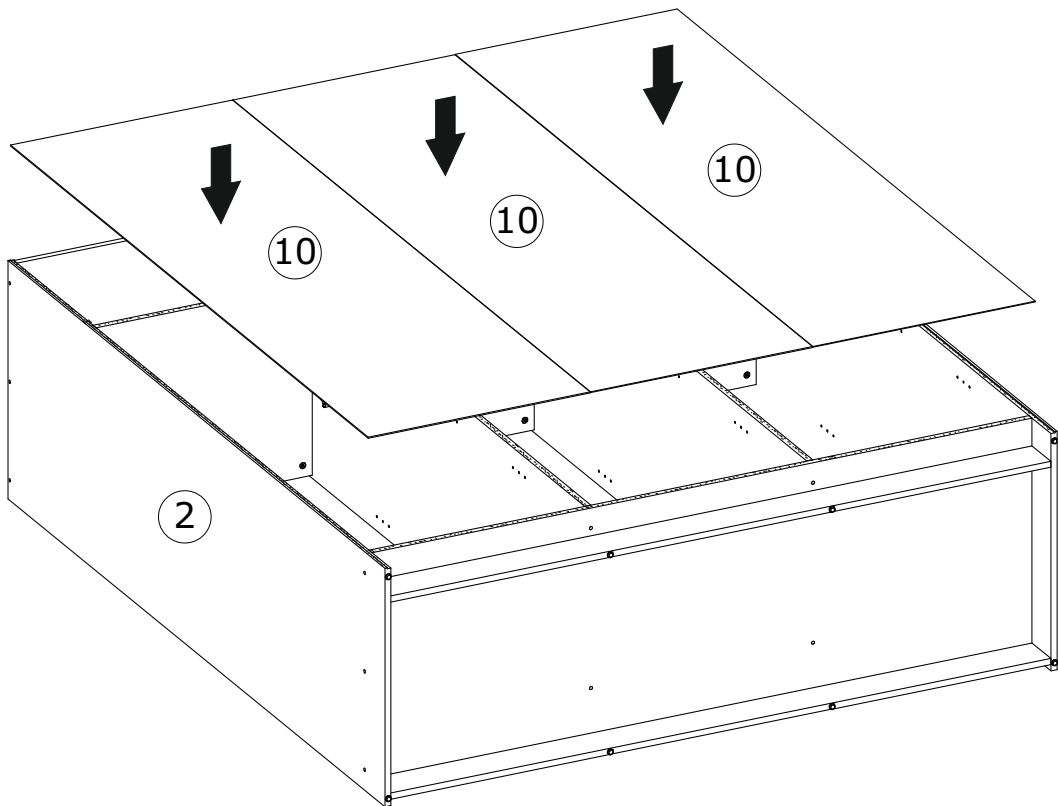

21

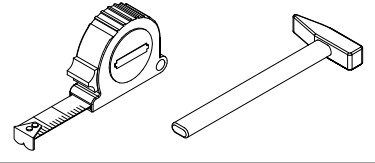
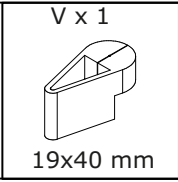
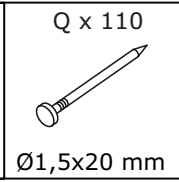
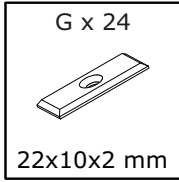

$XX = YY \cong 90^\circ$

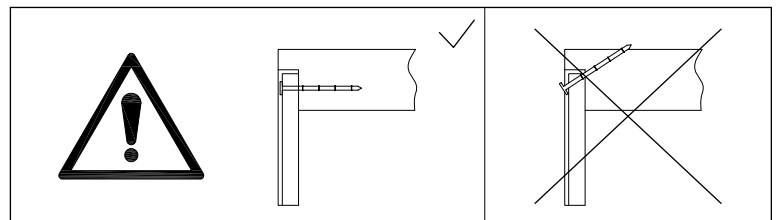
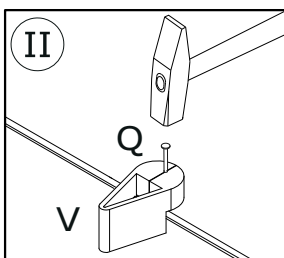
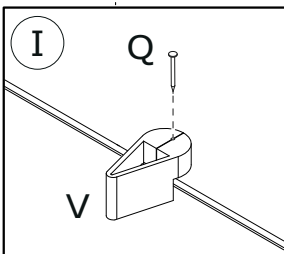
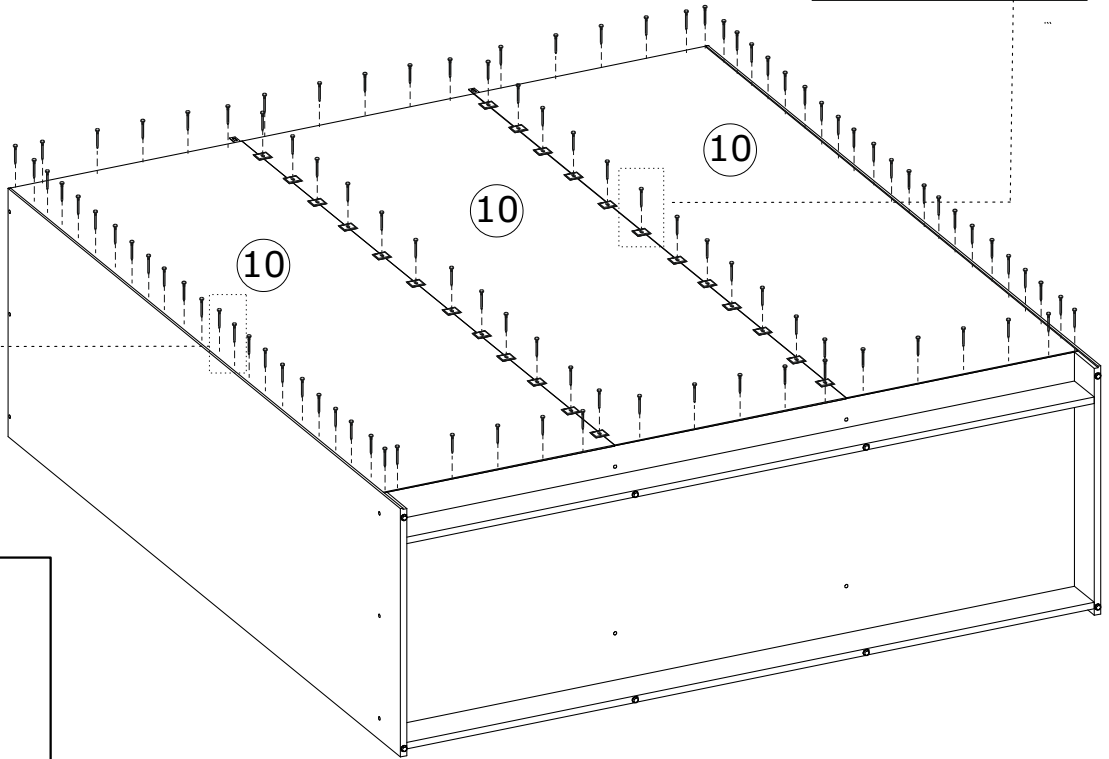
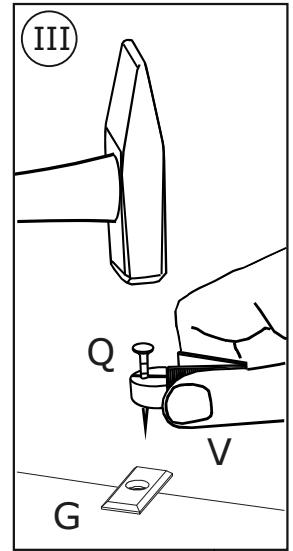
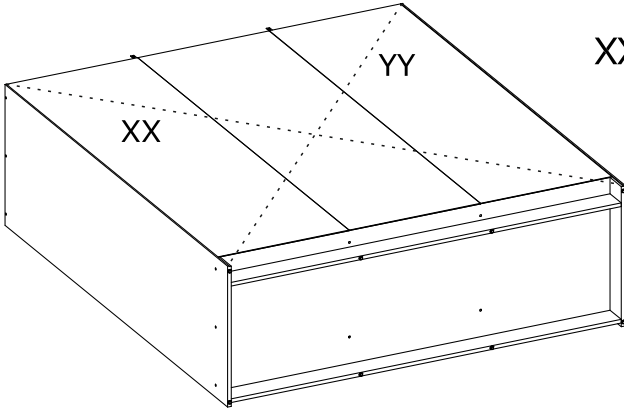

22



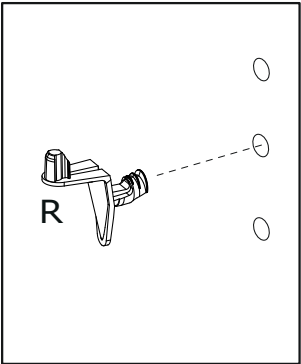
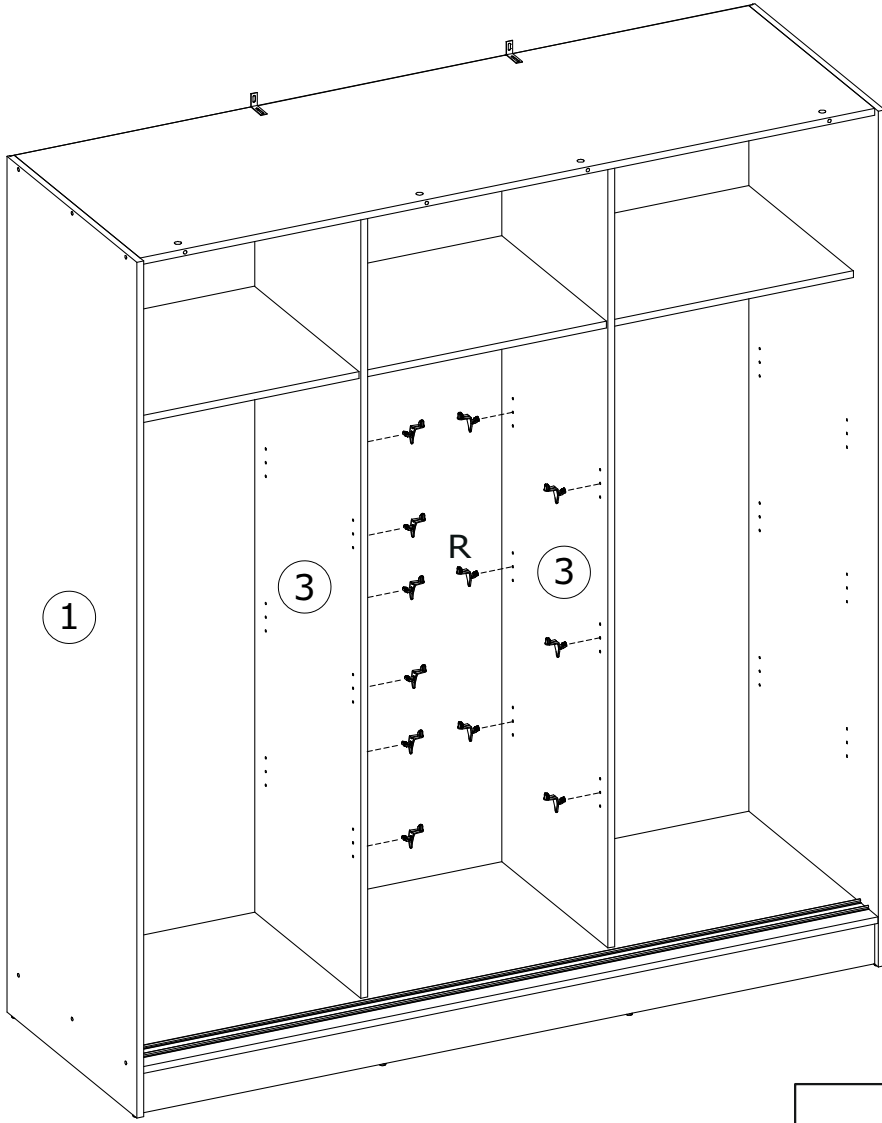

R x 12
20x19x11 mm

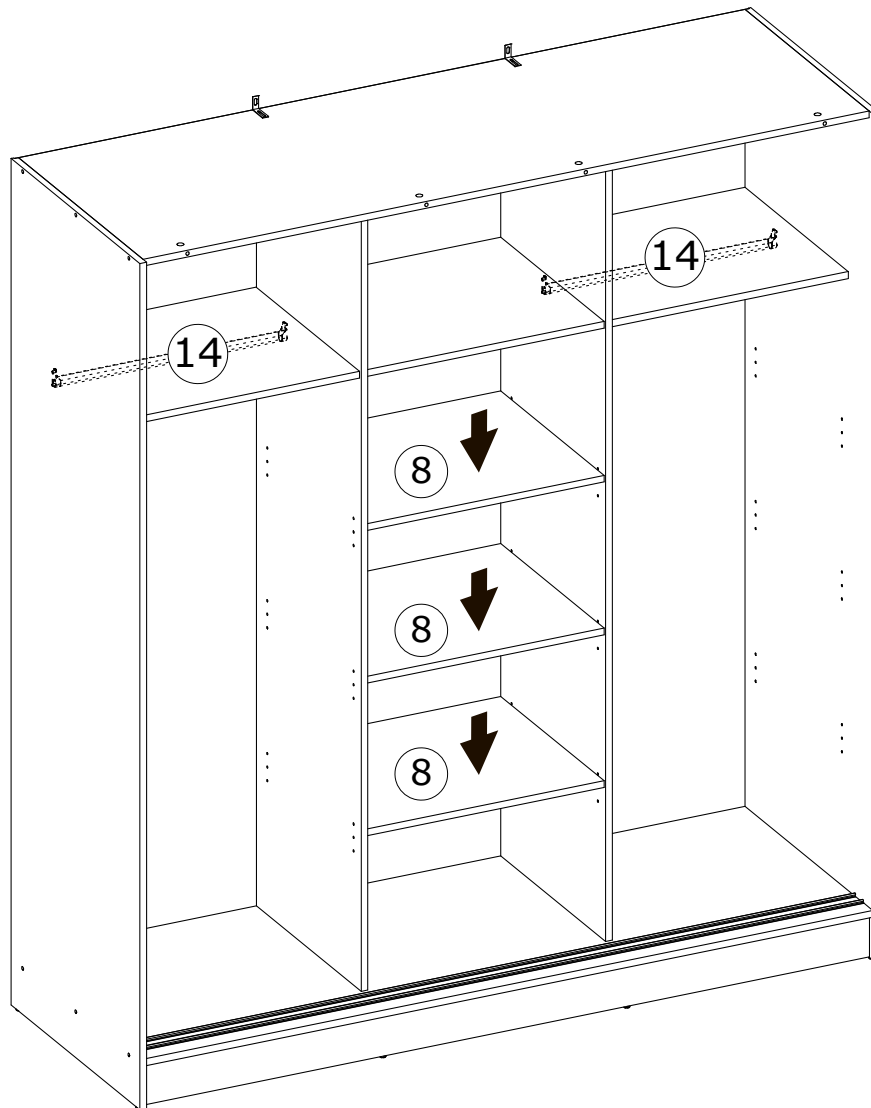
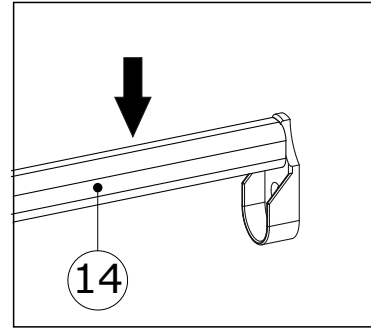
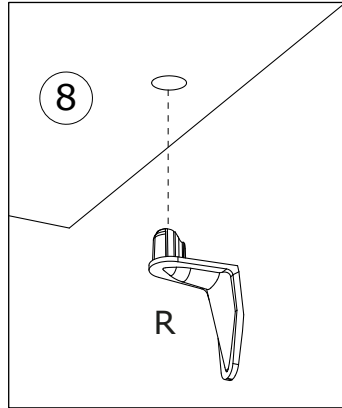

23

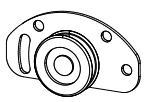
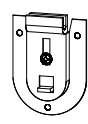
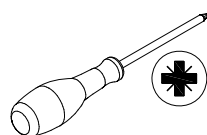

24

W x 12  Ø3,5x16 mm	Y x 8  Ø6,3x13 mm	K x 4  78x44x14 mm	J x 4  71x52x13 mm	 
---	--	---	---	--

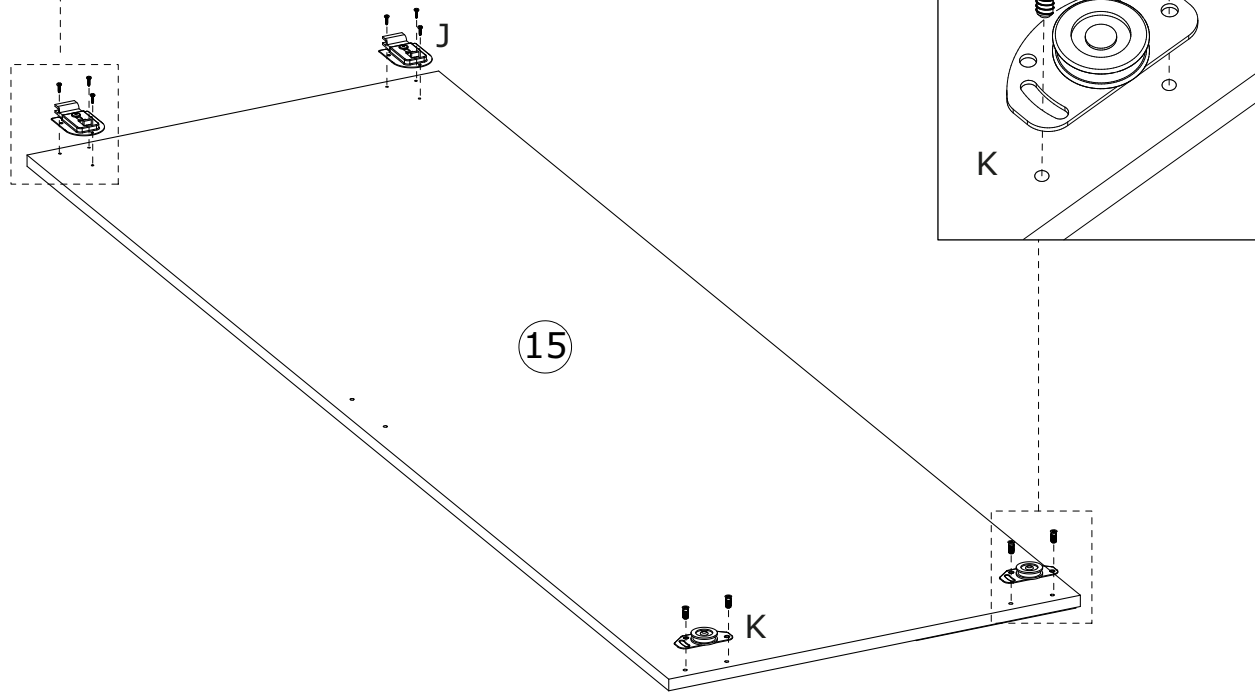
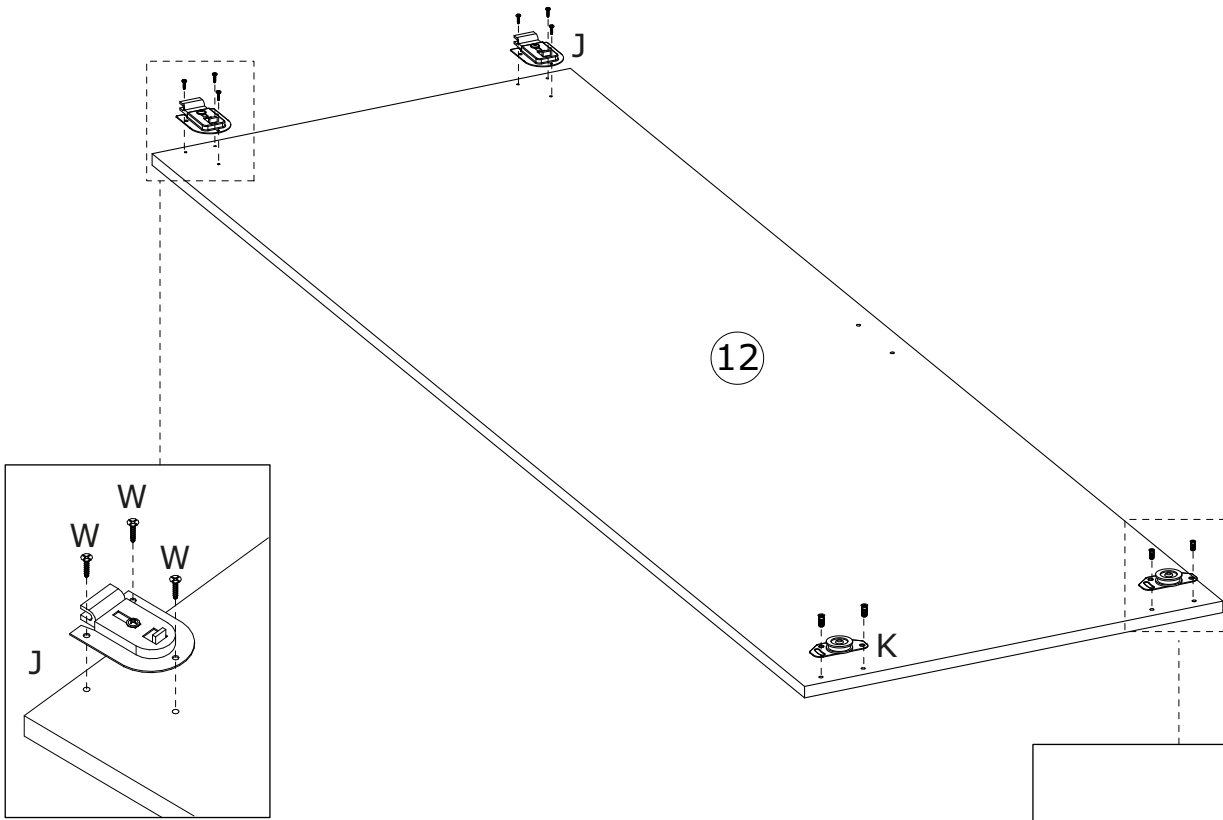

25

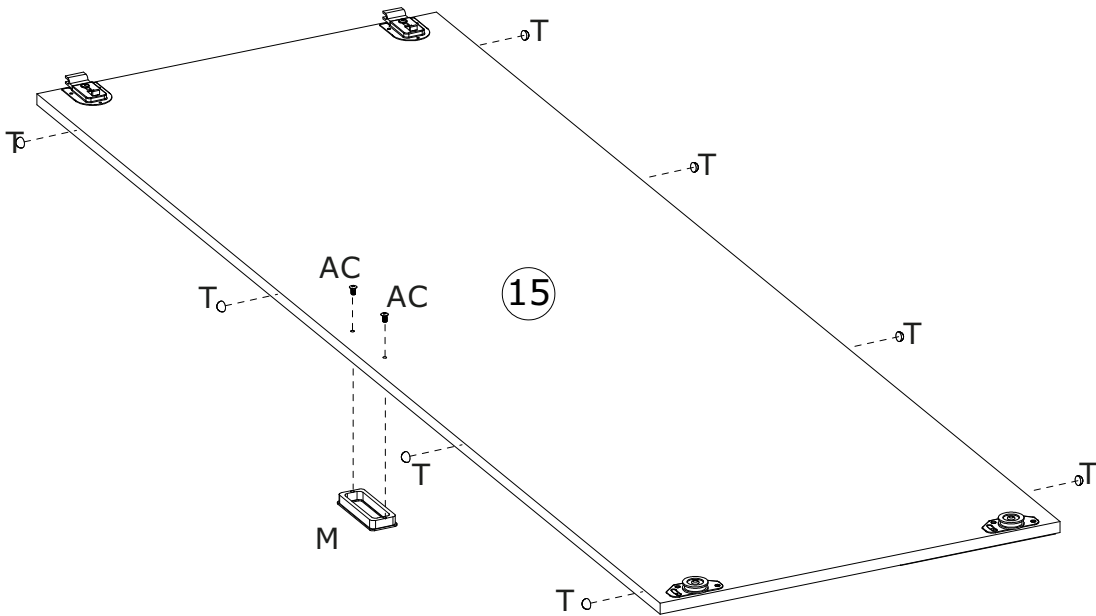
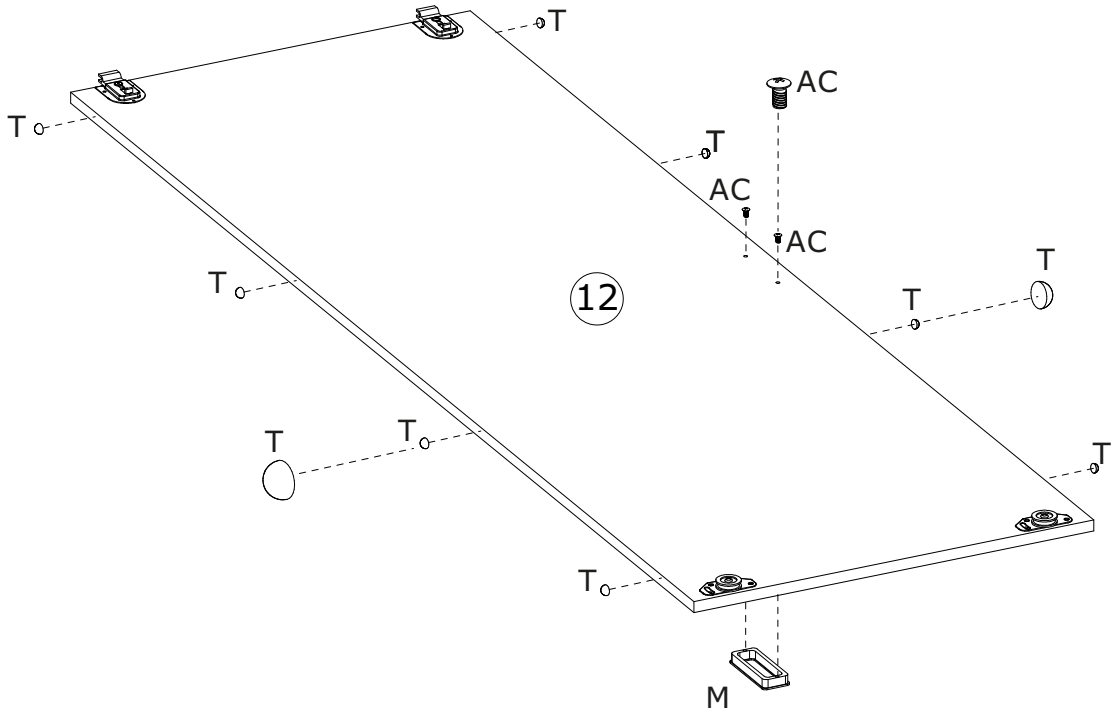

T x 16  Ø8 mm	M x 2  108x42x15 mm	AC x 4  M4x9 mm	
--	--	--	---

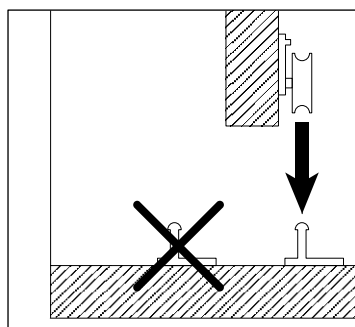
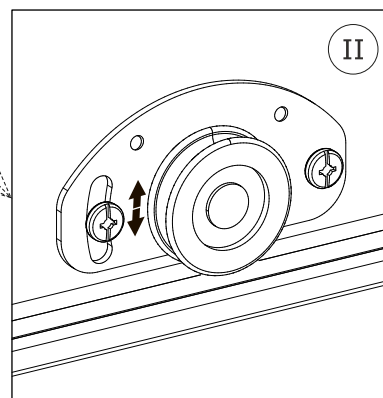
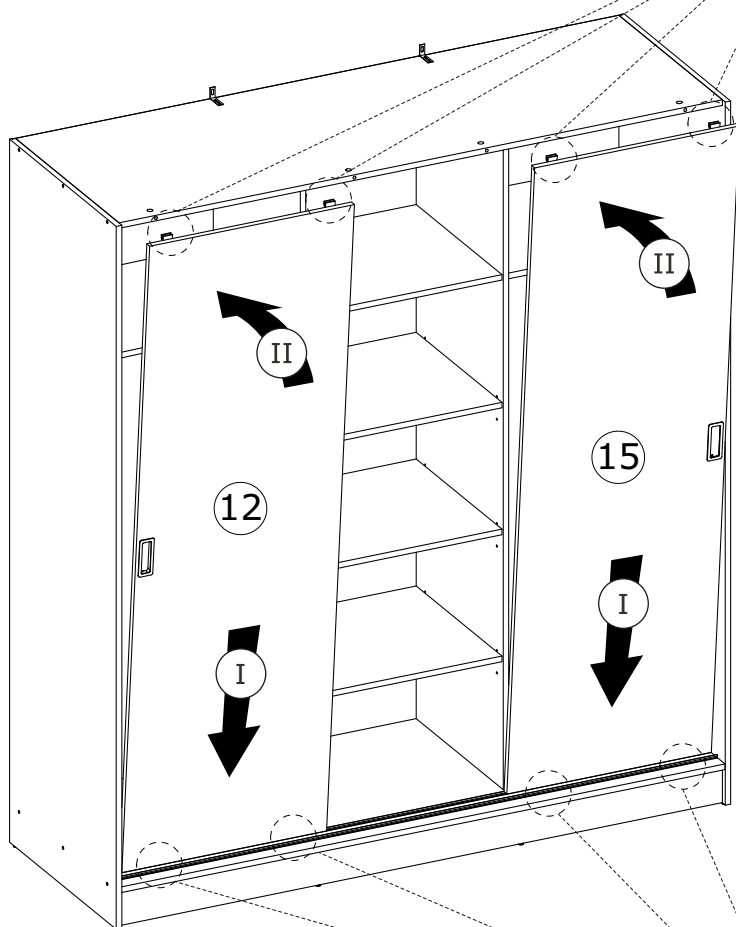
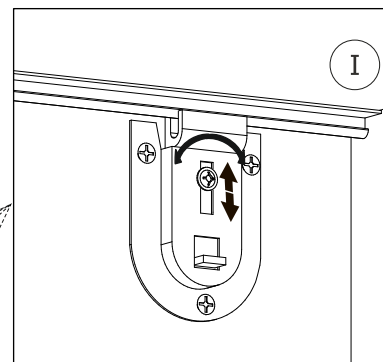
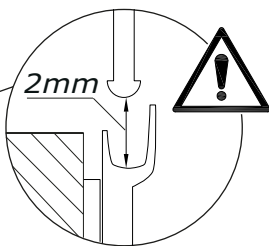
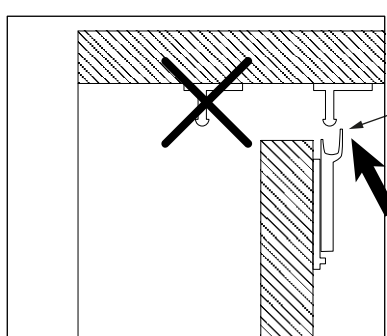
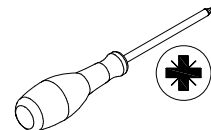

26

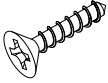

27

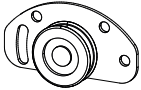
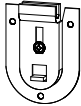
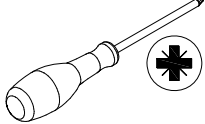
<p>W x 6  Ø3,5x16 mm</p>	<p>Y x 4  Ø6,3x13 mm</p>	<p>K x 2  78x44x14 mm</p>	<p>J x 2  71x52x13 mm</p>	
---	---	--	--	---

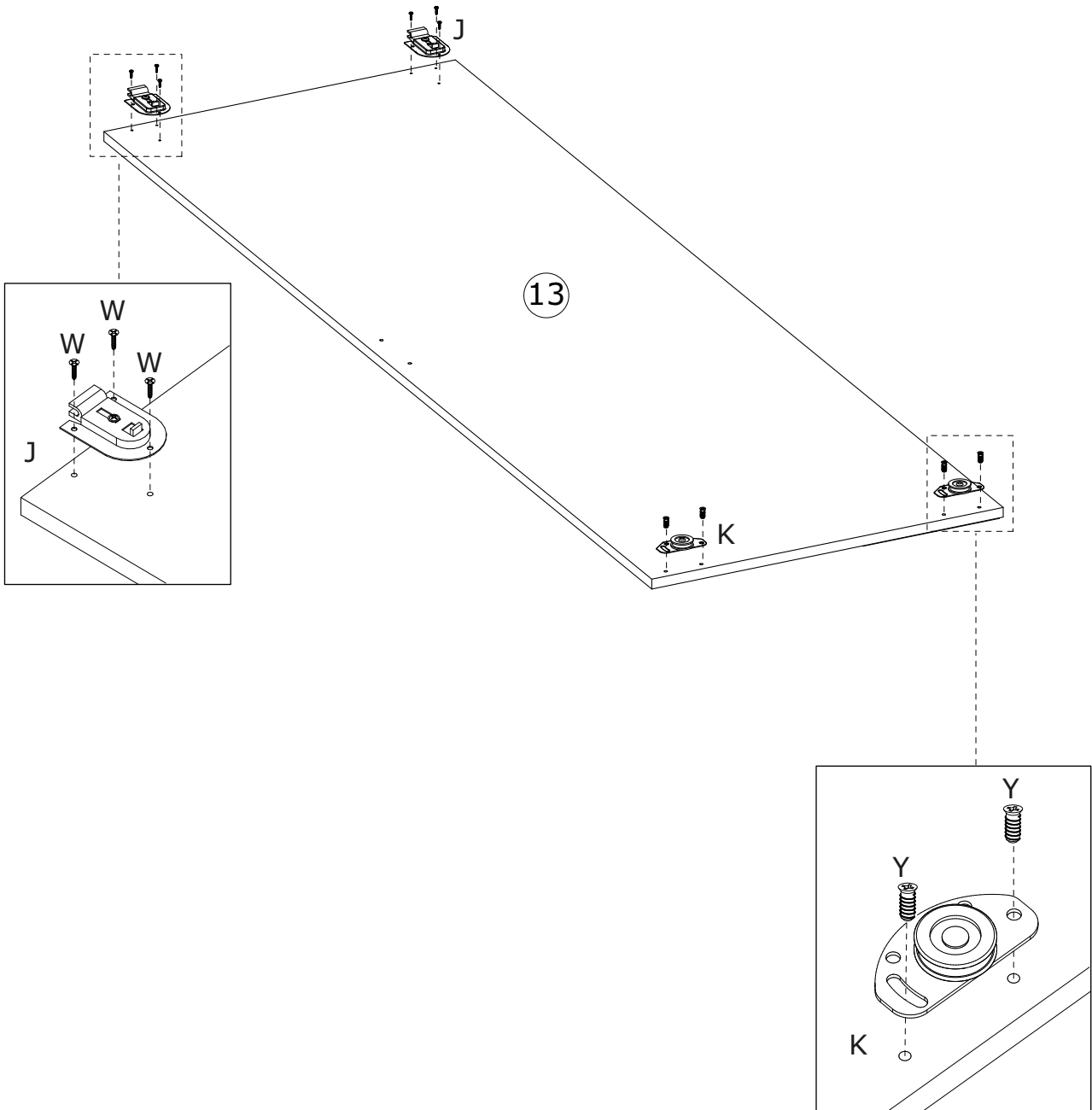

28

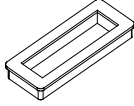
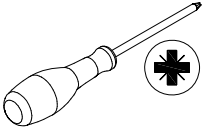
T x 8  Ø8 mm	M x 1  108x42x15 mm	AC x 2  M4x9 mm	
---	--	--	---

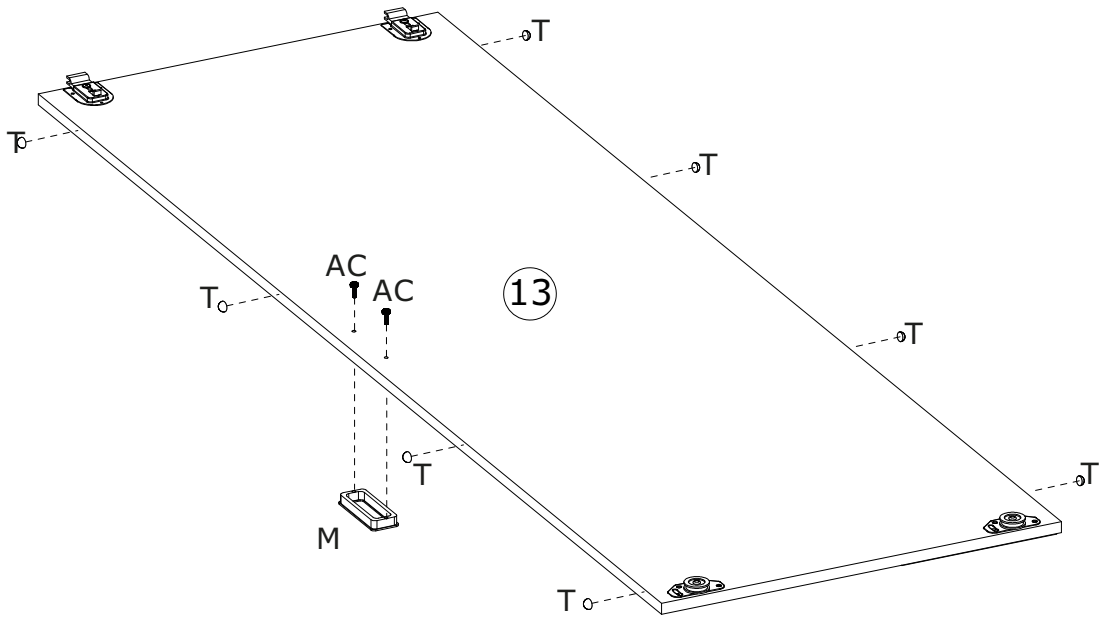

29

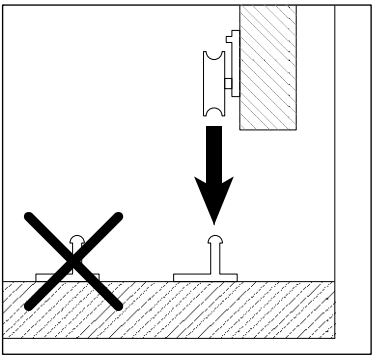
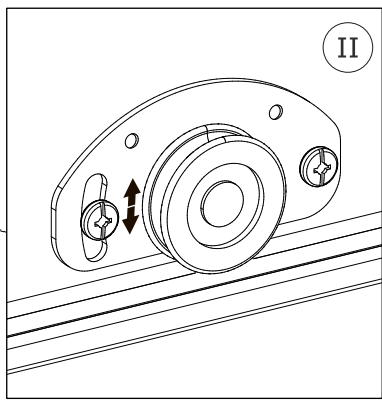
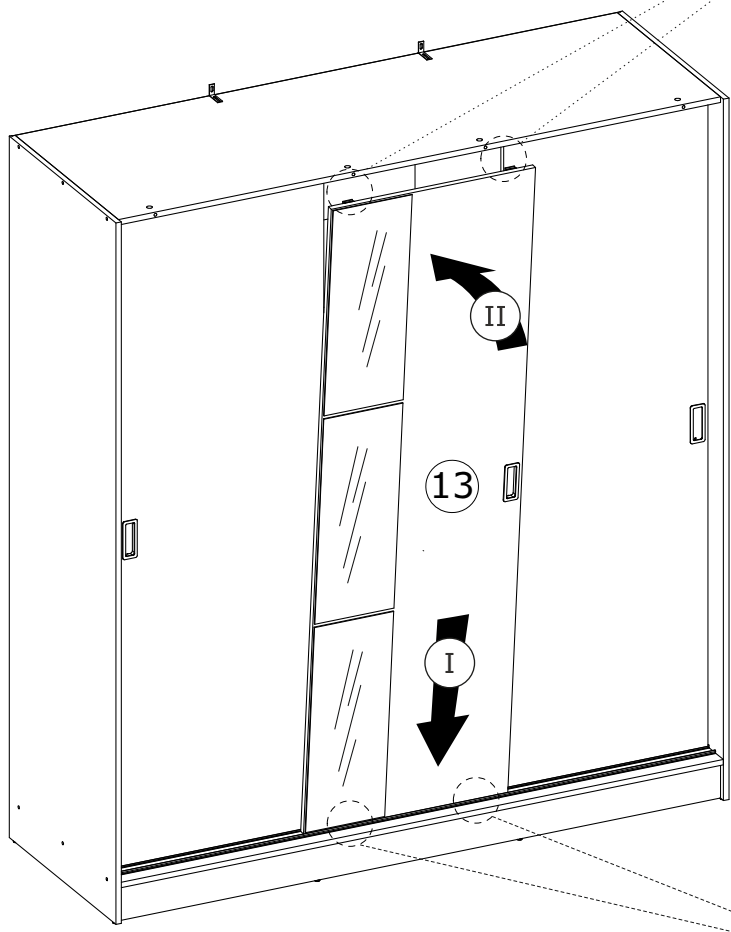
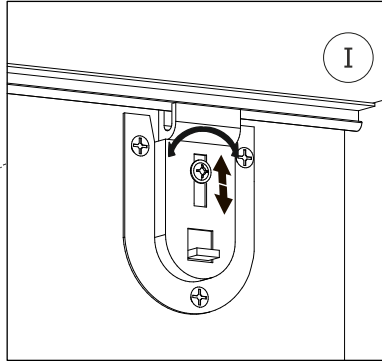
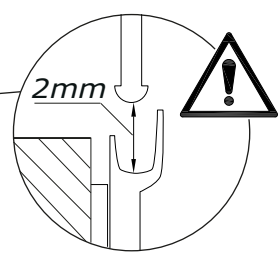
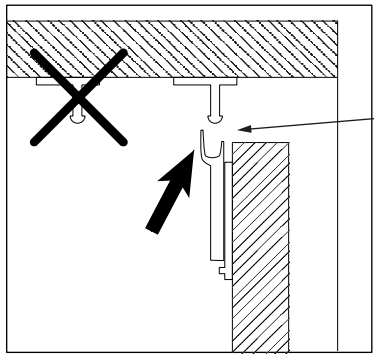
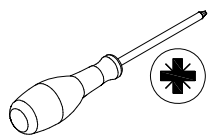

30

<p>A x 4</p>  <p>Ø7x44 mm</p>	
--	---

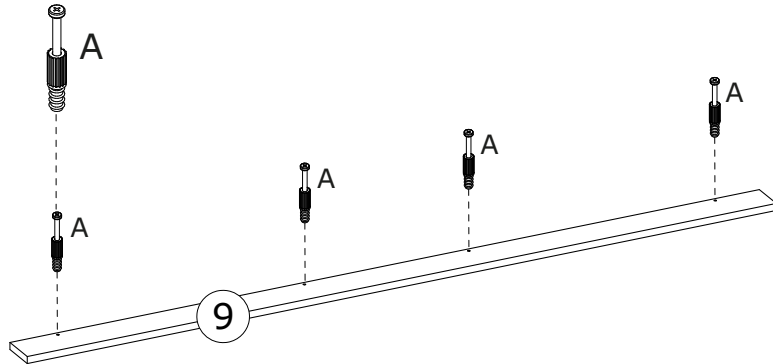

31

<p>B x 4</p>  <p>Ø15x12 mm</p>	
---	---

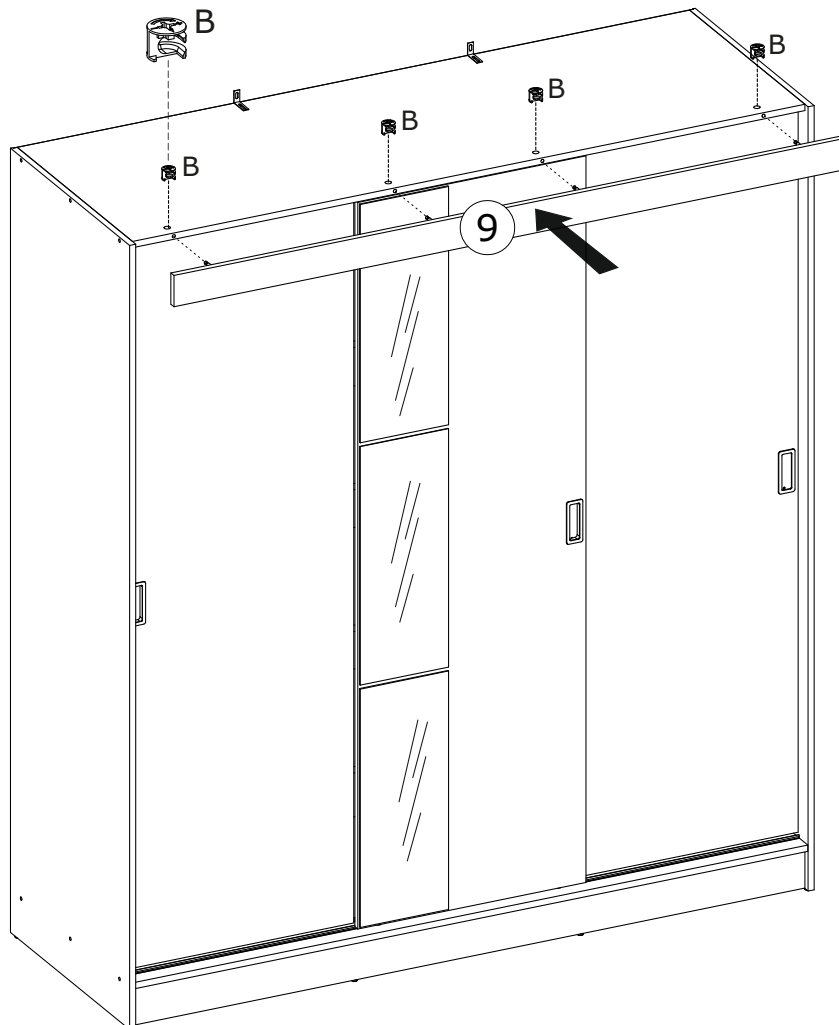

32

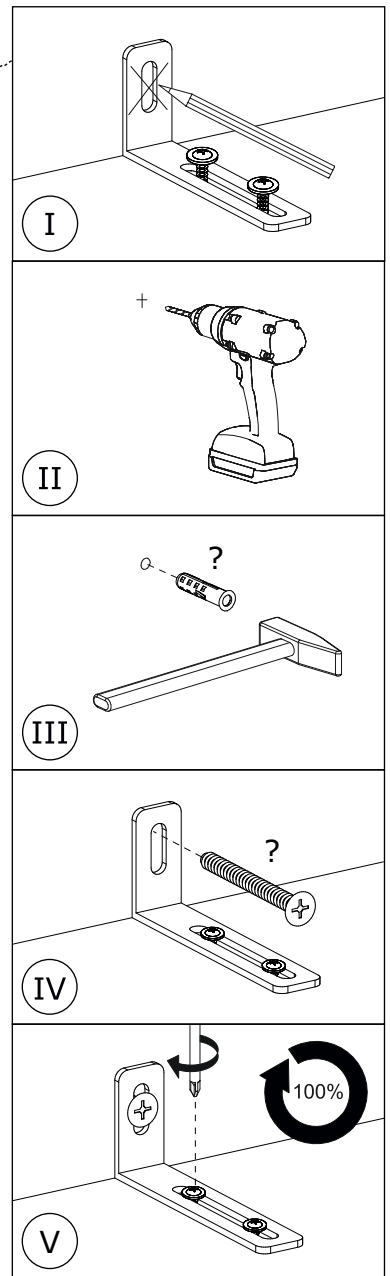
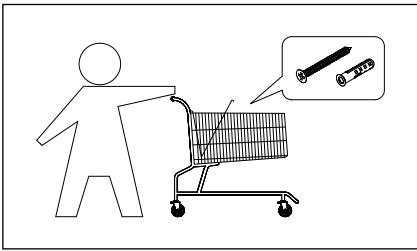
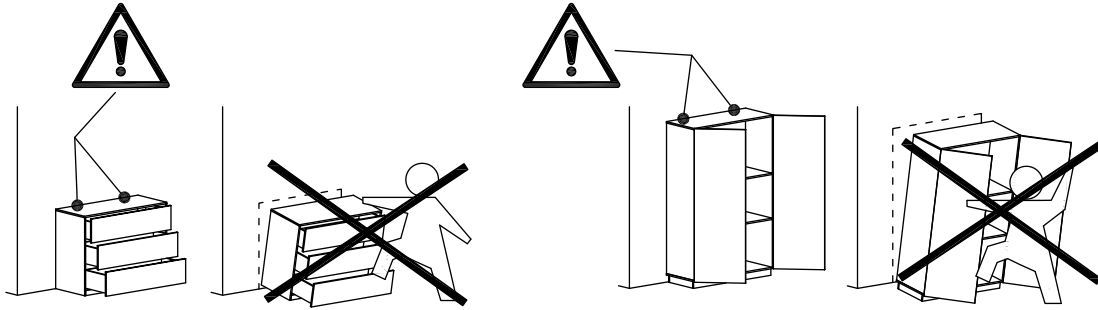
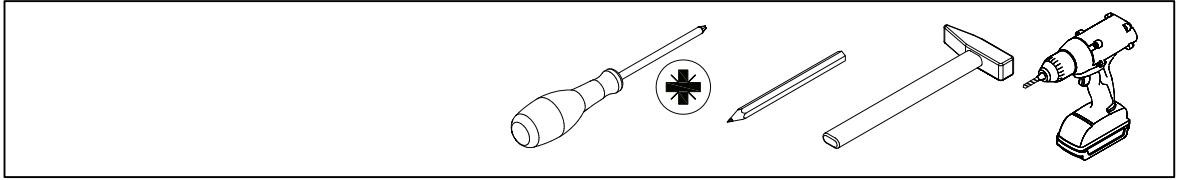

33

Z x 12	
	
Ø14 mm	

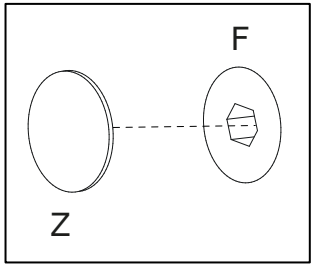
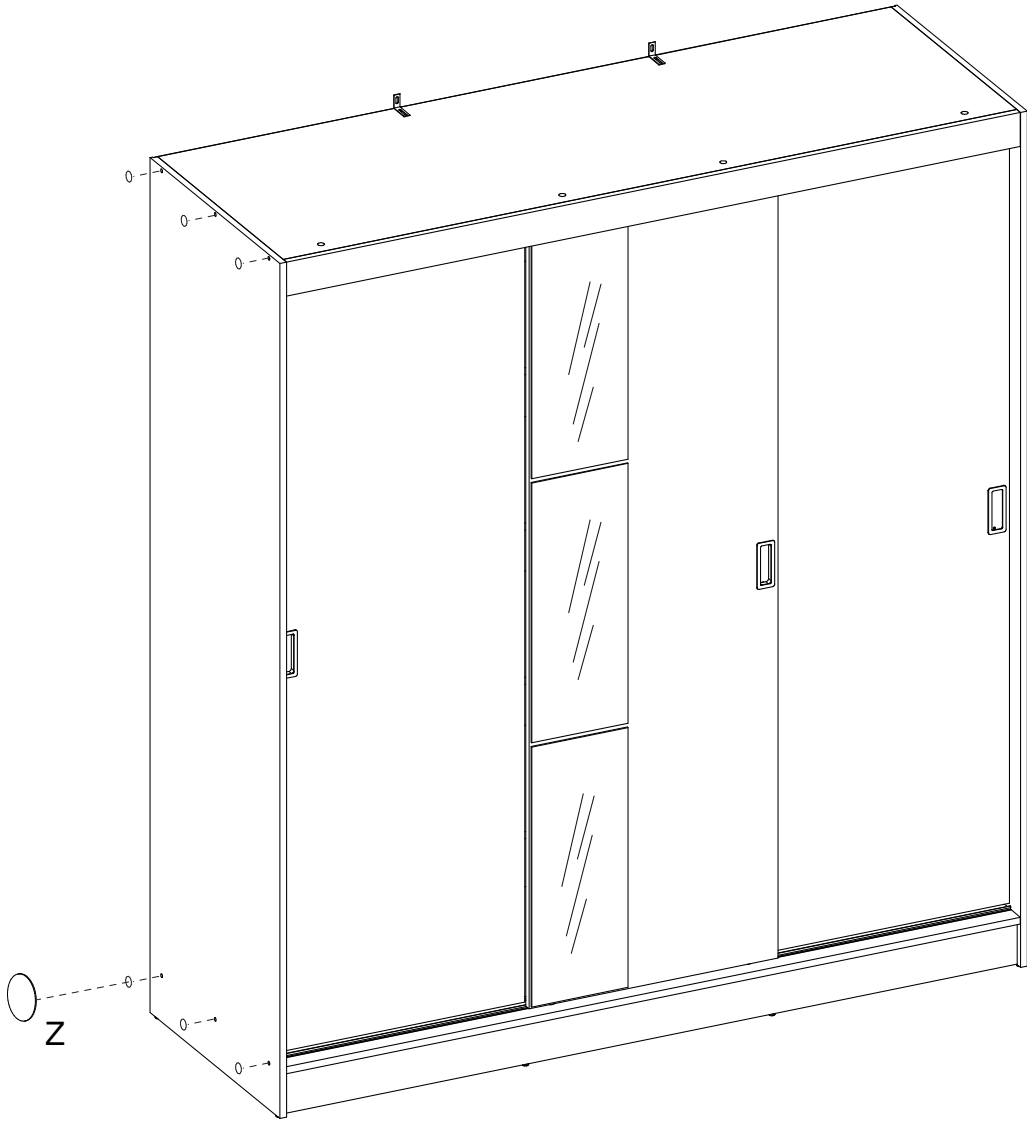

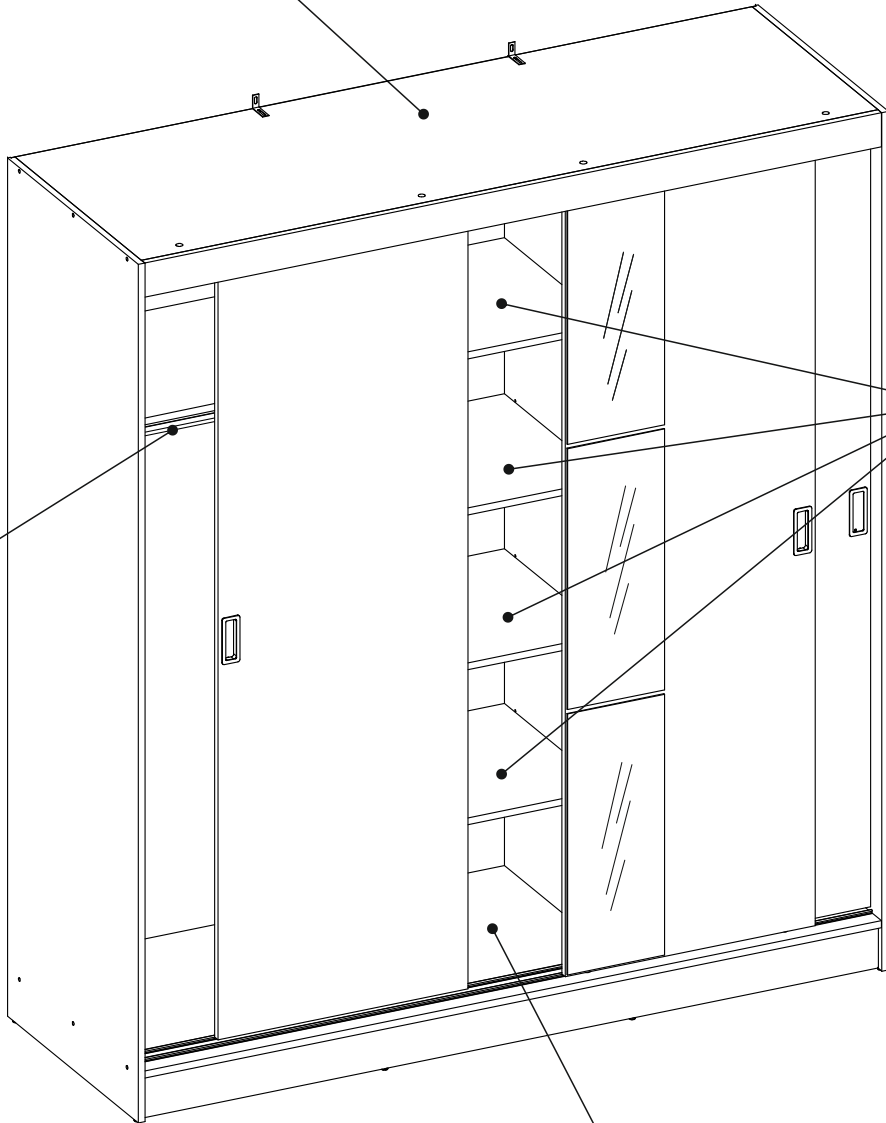

SIA "Do It",
Biķeru iela 4,
Ulbroka, Stopiņu
pagasts, Ropažu
novads, LV-2130,
Latvija;
info@doit.lv